



o u t d o o r s a u n a s

**DATASHEET**













**NA**  
SAUNAS

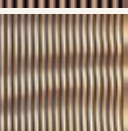
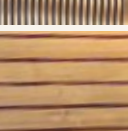



PAGE	MODEL	DIMENSIONS	WEIGHT
4	<b>Materials overview</b>	-	-
6	<b>Kiva</b>	227 x 208 x 230 cm	950 kg
8	<b>Kiva V2</b>	227 x 208 x 230 cm	1000 kg
10	<b>Kiva XL</b>	322 x 208 x 230 cm	1400 kg
12	<b>Kiva 44</b>	440 x 208 x 230 cm	2100 kg
14	<b>Kiva 54</b>	537 x 208 x 230 cm	2300 kg
16	<b>Cute</b>	227 x 233 x 230 cm	1050 kg
18	<b>Cute XL</b>	322 x 233 x 230 cm	1450 kg
20	<b>Cute 44</b>	440 x 233 x 230 cm	2200 kg
22	<b>Cute 54</b>	537 x 233 x 230 cm	2400 kg
24	<b>Balcony</b>	217 x 160 x 225 cm	900 kg
26	<b>Panorama</b>	220 x 200 x 225 cm	1000 kg
28	<b>Loma</b>	220x 220 x 233 cm	1300 kg
30	<b>Amade</b>	220 x 220 x 233 cm	1250 kg
32	<b>Amade XL</b>	300 x 220 x 233 cm	1700 kg
34	<b>Ischgl</b>	240 x 230 x 233 cm	1600 kg
36	<b>Grande</b>	225 x 300 x 242 cm	1500 kg
38	<b>Velden</b>	230 x 230 x 233 cm	1500 kg
40	<b>Velden XL</b>	330 x 230 x 233 cm	2100 kg
42	<b>Flora</b>	242 x 240 x 233 cm	1800 kg
44	<b>Woody</b>	306 x 230 x 245 cm	2000 kg
46	<b>Wellnes Oasis Small</b>	280 x 230 x 270 cm	2100 kg
48	<b>Wellnes Oasis</b>	407 x 245 x 286 cm	3500 kg
50	<b>Sauna House</b>	550 x 240 x 245 cm	4000 kg

# Materials overview

## Facade

-  GLASS
-  TYROL LAMELLAS
-  TYROL LAMELLAS BLACK
-  IPE VERTICAL
-  IPE WAVE
-  RHOMBUS LARCH
-  FMAX CAVE
-  FMAX MOONWALK
-  FMAX PATINA BRONZE
-  FMAX SKYLINE
-  FMAX STONEHENGE

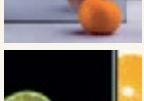
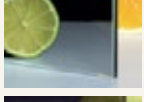
## Glazing

-  TRANSPARENT
-  MIRROR
-  MIRROR+
-  MIRROR BRONZE
-  PARSOL GREY
-  PARSOL DARK GREY
-  PARSOL BRONZE

## Flooring

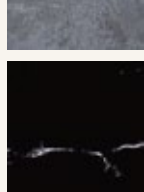
-  TILES
-  HPL

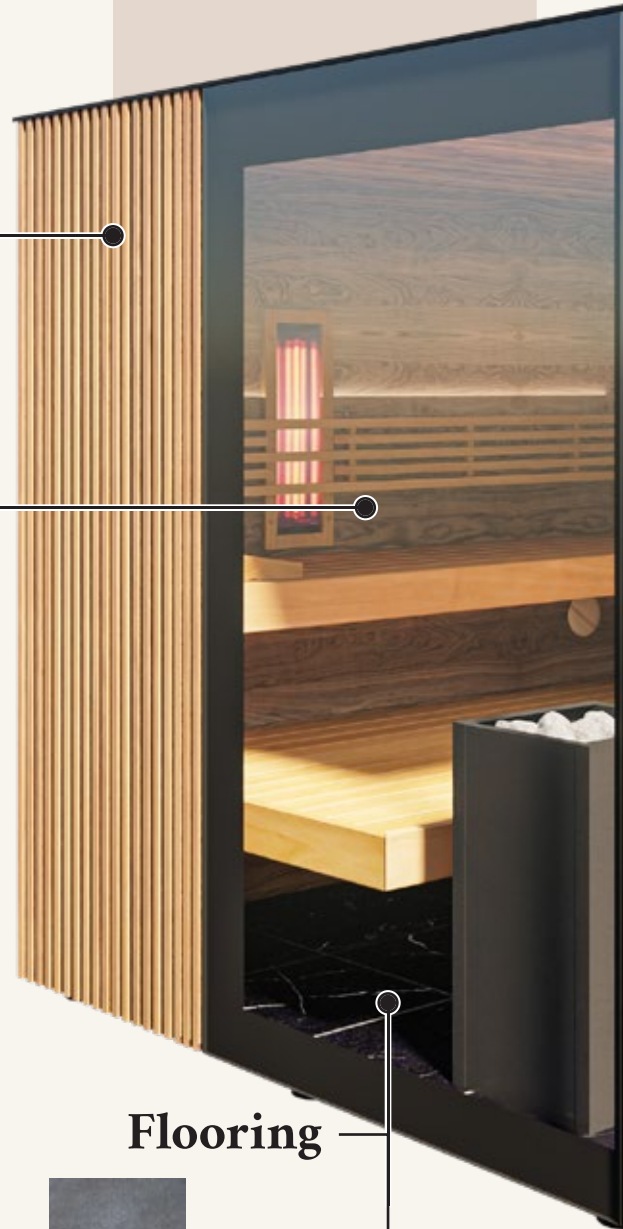

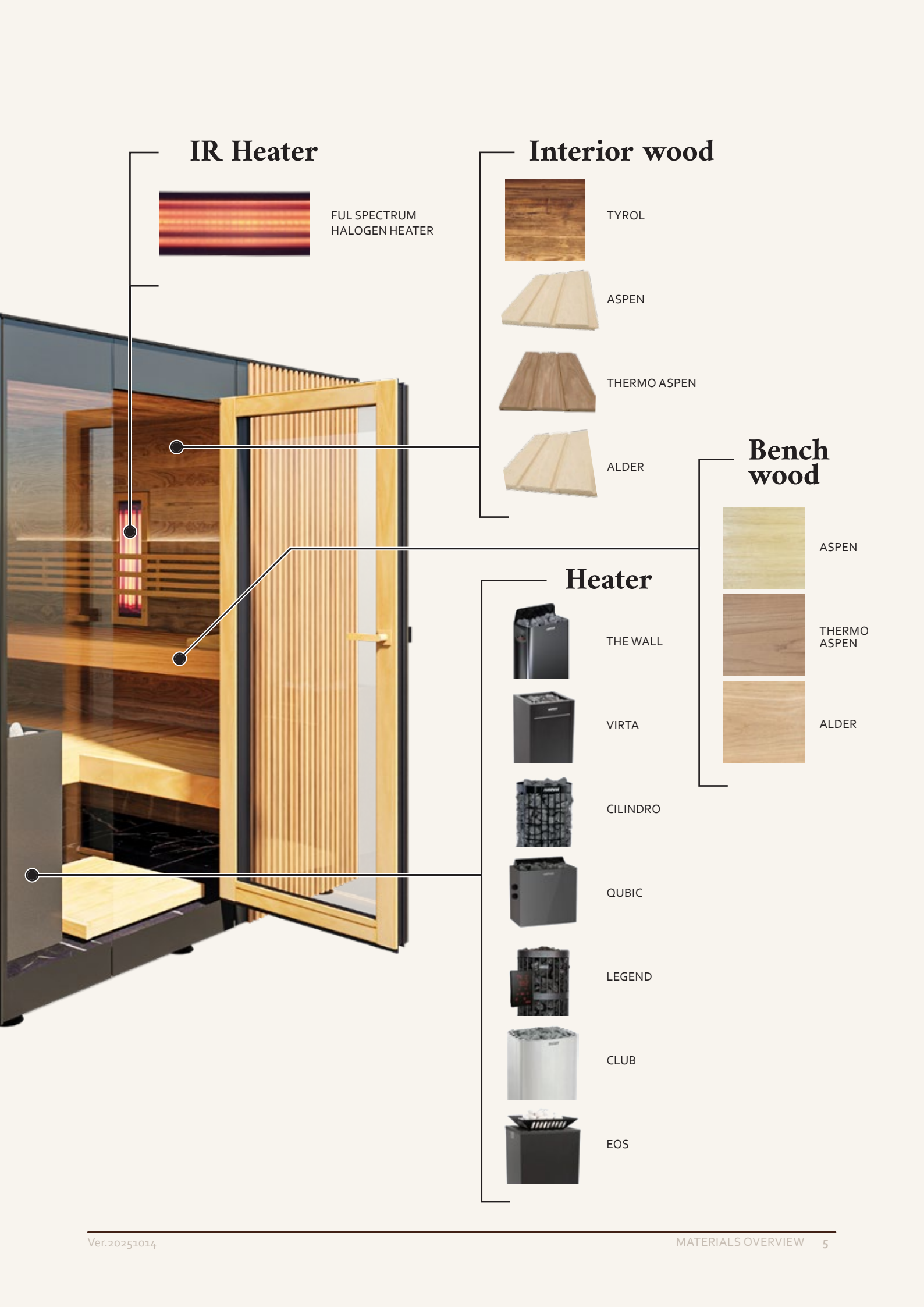

## IR Heater

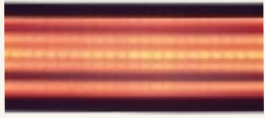

FUL SPECTRUM  
HALOGEN HEATER

## Interior wood

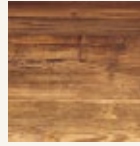

TYROL



ASPEN



THERMO ASPEN



ALDER

## Bench wood

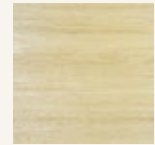

ASPEN

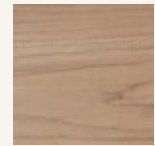

THERMO  
ASPEN

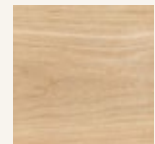

ALDER

## Heater



THE WALL



VIRTA



CILINDRO



QUBIC



LEGEND



CLUB



EOS

k  
kiva



fully  
prefabricated

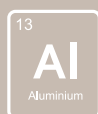

tough  
ALU door



massive  
interior



single  
glazing



dynamic  
facade

### Standard configuration:

DIMENSIONS	227x 208x 230 cm
WEIGHT	950 kg
WINDOWS / GLAZING	Front side single glazing 8mm / transparent glass
DOOR	Aluminium frame, non-locking, single glazed, transparent glass,
FLOORING	HPL
INTERIOR WALLS	Rustic tyrol wood cladding, heat treated and brushed
BENCHES	Thermo aspen
BACKREST	Thermo aspen
CONTROL UNIT	Harvia Fenix wifi control panel
COLOR LIGHT THERAPY	LED RGB under the bench and behind the backrest incl. remote control
HEATER	Harvia Qubic 9kW black steel
FACADES	Glass, tyrol lamellas natural, sheet metal on the back side
RAINWATER DRAINAGE	Along the rear-side drip plate

### Available options:

GLAZING	Parsol dark grey, mirror
DOOR	Door lock, antipanic - EN179
FACADES	Tyrol lamellas black painted
HEATERS	Fin and Bio heaters from Harvia, EOS, or any other manufacturer by request
ILLUMINATION	Digital addressable LED interior illumination, outdoor ambient illumination below sauna, vertical LED stripes integrated in facade
IR HEATERS	Up to 3 pcs full spectrum heaters



## Conditions to be provided by the customer:

**POWER CABLE:** 400 V / 5 x 2.5 mm<sup>2</sup> wire gauge, 3 x 16 Amp C-type fuse, 2 meter length, equipped with 400 volt 16A-6p-6h IP44 female connector. Your sauna will be supplied with the corresponding compatible connector, facilitating a hassle-free and secure electrical connection.

**FOUNDATION:** Flat and solid; a reinforced concrete slab, matching the dimensions of the sauna, with a thickness of 15 cm, the sauna is set on adjustable feet for leveling and alignment.

**INSTALLATION:** Accessibility to the installation site for crane delivery must be checked and ensured. **IMPORTANT:** It is the customer's responsibility to arrange for the crane or other delivery means and to clarify all requirements for installation in advance.

**DELIVERY & ASSEMBLY:** The sauna is prefabricated in the factory and is delivered directly to the construction site by prior arrangement. Generally, the customer is responsible for organizing all installation measures unless otherwise agreed. Final assembly, including electrical connection for testing, commissioning, functional testing, training, and handover will be carried out by the seller's or manufacturer's assembly team.

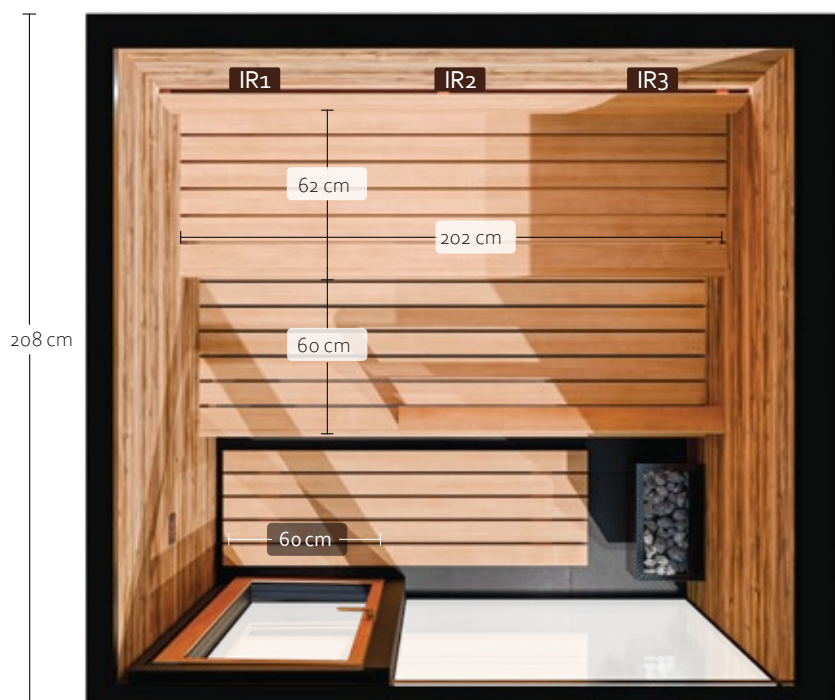
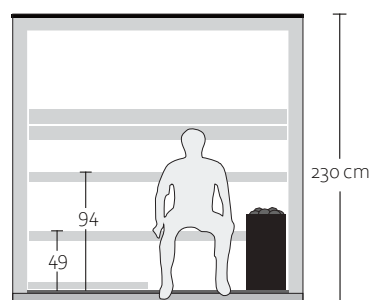
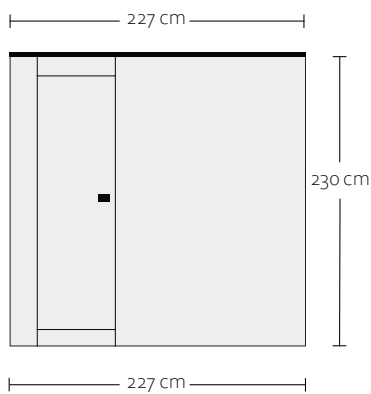



**k**  
kiva V2

				
<b>fully prefabricated</b>	<b>tough ALU door</b>	<b>massive interior</b>	<b>single glazing</b>	<b>dynamic facade</b>

**Standard configuration:**

<b>DIMENSIONS</b>	227x 208x 230 cm
<b>WEIGHT</b>	1000 kg
<b>WINDOWS / GLAZING</b>	Front side single glazing 8mm / transparent glass
<b>DOOR</b>	Aluminium frame, non-locking, single glazed, transparent glass
<b>FLOORING</b>	HPL
<b>INTERIOR WALLS</b>	Rustic tyrol wood cladding, heat treated and brushed
<b>BENCHES</b>	Thermo aspen
<b>BACKREST</b>	Thermo aspen
<b>CONTROL UNIT</b>	Harvia Fenix Wifi control panel
<b>COLOR LIGHT THERAPY</b>	LED RGB under the bench and behind the backrest incl. remote control
<b>HEATER</b>	Harvia Qubic 9kW black steel
<b>FACADES</b>	Glass, tyrol lamellas natural, sheet metal on the back side
<b>GLAZING</b>	Transparent
<b>RAINWATER DRAINAGE</b>	Along the rear-side drip plate

**Available options:**

<b>GLAZING</b>	Parsol dark grey, mirror
<b>DOOR</b>	Door lock, antipanic - EN179
<b>FACADES</b>	Tyrol black painted
<b>HEATERS</b>	Fin and Bio heaters from Harvia, EOS, or any other manufacturer by request
<b>ILLUMINATION</b>	Digital addressable LED interior illumination, outdoor ambient illumination below sauna, vertical LED stripes integrated in facade
<b>IR HEATERS</b>	Up to 3 pcs full spectrum heaters

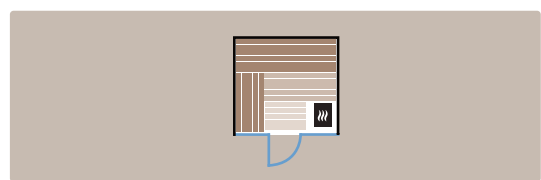

## Conditions to be provided by the customer:

**POWER CABLE:** 400 V / 5 x 2.5 mm<sup>2</sup> wire gauge, 3 x 16 Amp C-type fuse, 2 meter length, equipped with 400 volt 16A-6p-6h IP44 female connector. Your sauna will be supplied with the corresponding compatible connector, facilitating a hassle-free and secure electrical connection.

**FOUNDATION:** Flat and solid; a reinforced concrete slab, matching the dimensions of the sauna, with a thickness of 15 cm, the sauna is set on adjustable feet for leveling and alignment.

**INSTALLATION:** Accessibility to the installation site for crane delivery must be checked and ensured. **IMPORTANT:** It is the customer's responsibility to arrange for the crane or other delivery means and to clarify all requirements for installation in advance.

**DELIVERY & ASSEMBLY:** The sauna is prefabricated in the factory and is delivered directly to the construction site by prior arrangement. Generally, the customer is responsible for organizing all installation measures unless otherwise agreed. Final assembly, including electrical connection for testing, commissioning, functional testing, training, and handover will be carried out by the seller's or manufacturer's assembly team.

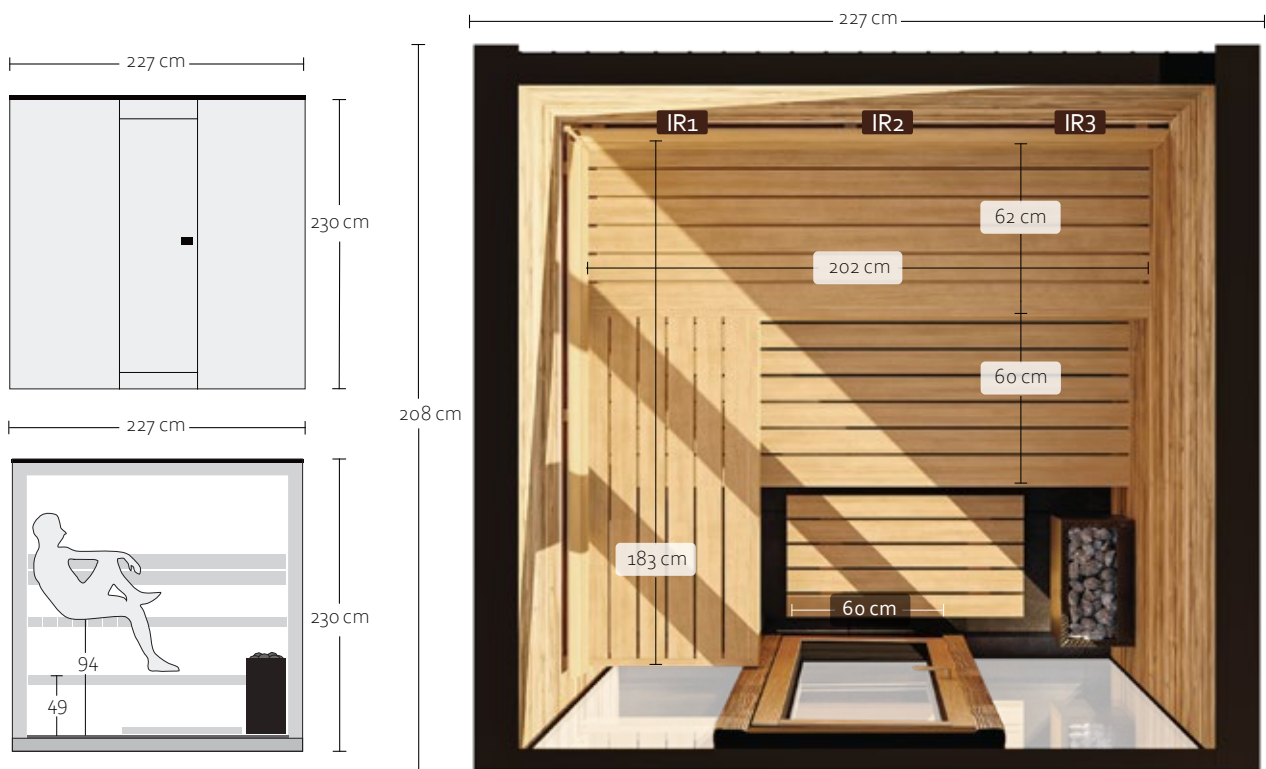

# k

## kiva xl



fully  
prefabricated

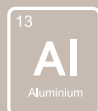

tough  
ALU door



massive  
interior



single  
glazing



dynamic  
facade

### Standard configuration:

DIMENSIONS	322 x 208 x 230 cm
WEIGHT	1400 kg
WINDOWS / GLAZING	Front side single glazing 8mm / transparent glass
DOOR	Aluminium frame, non-locking, single glazed
FLOORING	HPL
INTERIOR WALLS	Rustic tyrol wood cladding, heat treated and brushed
BENCHES	Thermo aspen
BACKREST	Thermo aspen
CONTROL UNIT	Harvia Fenix wifi control panel
COLOR LIGHT THERAPY	LED RGB under the bench and behind the backrest incl. remote control
HEATER	Harvia Qubic gkW black steel
FACADES	Glass, tyrol lamellas natural, sheet metal on the back side
RAINWATER DRAINAGE	Along the rear-side drip plate

### Available options:

GLAZING	Parsol dark grey, mirror
DOOR	Door lock, antipanic - EN179
FACADES	Tyrol lamellas black painted
HEATERS	Fin and Bio heaters from Harvia, EOS, or any other manufacturer by request
ILLUMINATION	Digital addressable LED interior illumination, outdoor ambient illumination below sauna, vertical LED stripes integrated in facade
IR HEATERS	Up to 3 pcs full spectrum heaters



## Conditions to be provided by the customer:

**POWER CABLE:** 400 V / 5 x 2.5 mm<sup>2</sup> wire gauge, 3 x 16 Amp C-type fuse, 2 meter length, equipped with 400 volt 16A-6p-6h IP44 female connector. Your sauna will be supplied with the corresponding compatible connector, facilitating a hassle-free and secure electrical connection.

**FOUNDATION:** Flat and solid; a reinforced concrete slab, matching the dimensions of the sauna, with a thickness of 15 cm, the sauna is set on adjustable feet for leveling and alignment.

**INSTALLATION:** Accessibility to the installation site for crane delivery must be checked and ensured. **IMPORTANT:** It is the customer's responsibility to arrange for the crane or other delivery means and to clarify all requirements for installation in advance.

**DELIVERY & ASSEMBLY:** The sauna is prefabricated in the factory and is delivered directly to the construction site by prior arrangement. Generally, the customer is responsible for organizing all installation measures unless otherwise agreed. Final assembly, including electrical connection for testing, commissioning, functional testing, training, and handover will be carried out by the seller's or manufacturer's assembly team.

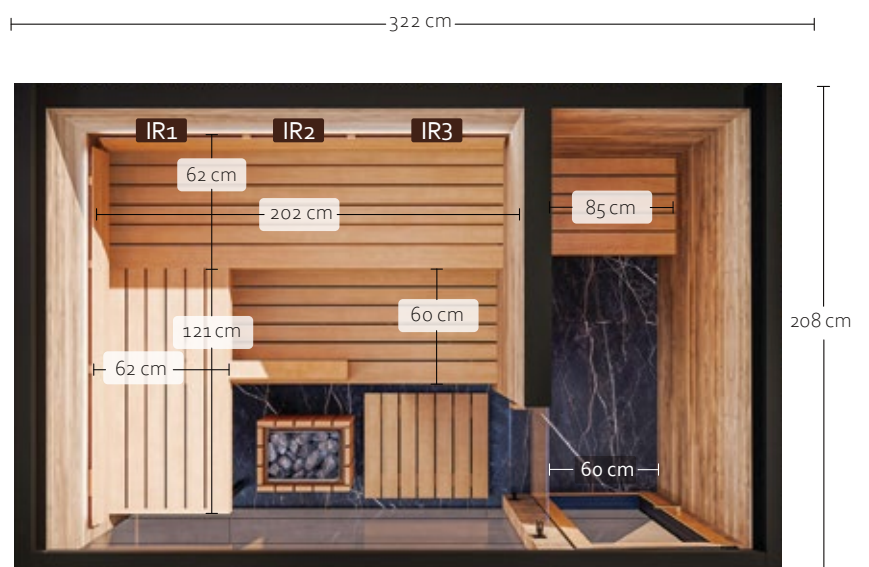
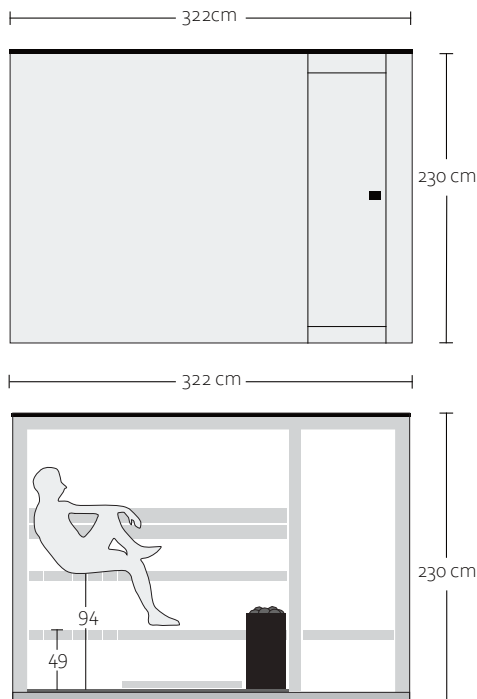

# k

## kiva 44



**fully  
prefabricated**

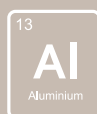

**tough  
ALU door**



**massive  
interior**



**single  
glazing**



**dynamic  
facade**

### Standard configuration:

DIMENSIONS	440 x 208 x 230 cm
WEIGHT	2100 kg
WINDOWS / GLAZING	Front side single glazing 8mm / transparent glass
DOOR	Aluminium frame, non-locking, single glazed, transparent glass
FLOORING	HPL
INTERIOR WALLS	Rustic tyrol wood cladding, heat treated and brushed
BENCHES	Thermo aspen
BACKREST	Thermo aspen
CONTROL UNIT	Harvia Fenix wifi control panel
COLOR LIGHT THERAPY	LED RGB under the bench and behind the backrest incl. remote control
HEATER	Harvia Qubic 6kW Black steel
LOUNGE HEATING	Ceiling IR 700W
FACADES	Glass, tyrol lamellas natural, sheet metal on the back side
RAINWATER DRAINAGE	Along the rear-side drip plate

### Available options:

GLAZING	Parsol dark grey, mirror
DOOR	Door lock, antipanic - EN179
FACADES	Tyrol lamellas black painted
HEATERS	Fin and Bio heaters from Harvia, EOS, or any other manufacturer by request,
LOUNGE HEATING	Floor heating 400W (4 m <sup>2</sup> )
ILLUMINATION	Digital addressable LED interior illumination, outdoor ambient illumination below sauna, vertical LED stripes integrated in facade
IR HEATERS	Up to 3 pcs full spectrum heaters



## Conditions to be provided by the customer:

**POWER CABLE:** 400V / 5 x 2.5 mm<sup>2</sup> wire gauge, 3 x 16 Amp C-type fuse, 2 meter length, equipped with 400 volt 16A-6p-6h IP44 female connector. Your sauna will be supplied with the corresponding compatible connector, facilitating a hassle-free and secure electrical connection.

**FOUNDATION:** Flat and solid; a reinforced concrete slab, matching the dimensions of the sauna, with a thickness of 15 cm, the sauna is set on adjustable feet for leveling and alignment.

**INSTALLATION:** Accessibility to the installation site for crane delivery must be checked and ensured. **IMPORTANT:** It is the customer's responsibility to arrange for the crane or other delivery means and to clarify all requirements for installation in advance.

**DELIVERY & ASSEMBLY:** The sauna is prefabricated in the factory and is delivered directly to the construction site by prior arrangement. Generally, the customer is responsible for organizing all installation measures unless otherwise agreed. Final assembly, including electrical connection for testing, commissioning, functional testing, training, and handover will be carried out by the seller's or manufacturer's assembly team.

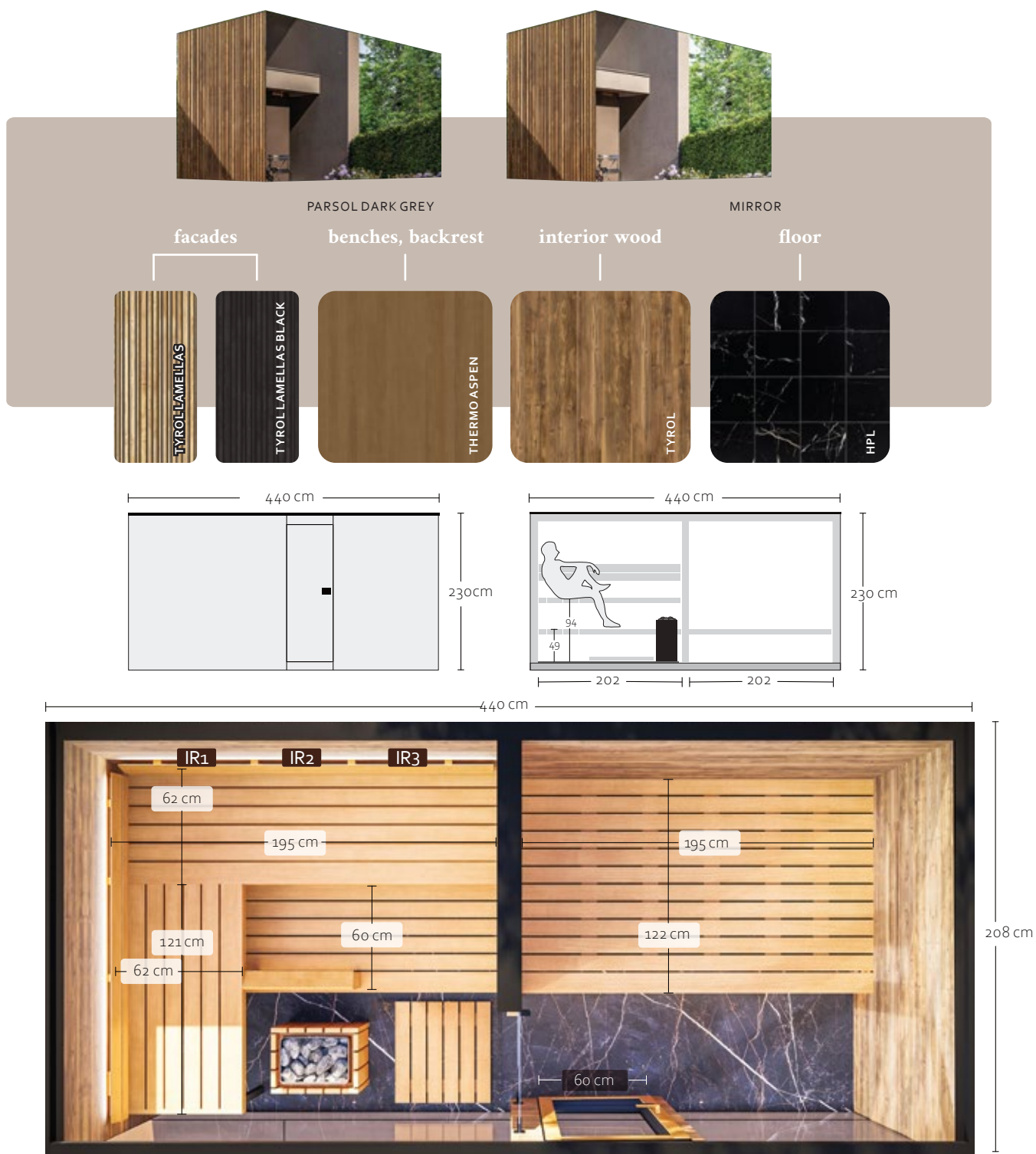

# k

## kiva 54



**fully  
prefabricated**

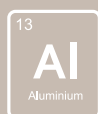

**tough  
ALU door**



**massive  
interior**



**single  
glazing**



**dynamic  
facade**

### Standard configuration:

DIMENSIONS	537x 208 x 230 cm
WEIGHT	2300 kg
WINDOWS / GLAZING	Front side single glazing 8mm / transparent glass
DOOR	Aluminium frame, non-locking, single glazed
FLOORING	HPL
INTERIOR WALLS	Rustic tyrol wood cladding, heat treated and brushed
BENCHES	Thermo aspen
BACKREST	Thermo aspen
CONTROL UNIT	Harvia Fenix wifi control panel
COLOR LIGHT THERAPY	LED RGB under the bench and behind the backrest incl. remote control
HEATER	Harvia Qubic 9kW black steel
LOUNGE HEATING	Ceiling IR 700W, floor heating 500W (5m <sup>2</sup> )
SHOWER	Shower
FACADES	Glass, tyrol lamellas natural, sheet metal on the back side
RAINWATER DRAINAGE	Along the rear-side drip plate

### Available options:

GLAZING	Parsol dark grey, mirror
DOOR	Door lock, antipanic - EN179
FACADES	Tyrol lamellas black painted
HEATERS	Fin and Bio heaters from Harvia, EOS, or any other manufacturer by request
ILLUMINATION	Digital addressable LED interior illumination, outdoor ambient illumination below sauna, Vertical LED stripes integrated in facade
IR HEATERS	Up to 3 pcs full spectrum heaters



## Conditions to be provided by the customer:

**POWER CABLE:** 400 V / 5 x 2.5 mm<sup>2</sup> wire gauge, 3 x 16 Amp C-type fuse, 2 meter length, equipped with 400 volt 16A-6p-6h IP44 female connector. Your sauna will be supplied with the corresponding compatible connector, facilitating a hassle-free and secure electrical connection.

**WATER SUPPLY:** Cold and hot water supply (¾" pipe), drain or wastewater connection prepared at site

**FOUNDATION:** Flat and solid; a reinforced concrete slab, matching the dimensions of the sauna, with a thickness of 15 cm, the sauna is set on adjustable feet for leveling and alignment.

**INSTALLATION:** Accessibility to the installation site for crane delivery must be checked and ensured. **IMPORTANT:** It is the customer's responsibility to arrange for the crane or other delivery means and to clarify all requirements for installation in advance.

**DELIVERY & ASSEMBLY:** The sauna is prefabricated in the factory and is delivered directly to the construction site by prior arrangement. Generally, the customer is responsible for organizing all installation measures unless otherwise agreed. Final assembly, including electrical connection for testing, commissioning, functional testing, training, and handover will be carried out by the seller's or manufacturer's assembly team.

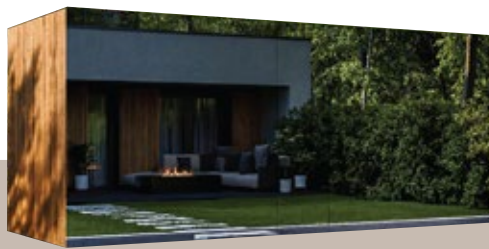

PARSOL DARK GREY



MIRROR

facades

benches, backrest

interior wood

floor

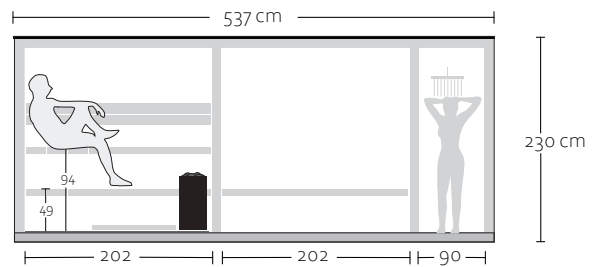
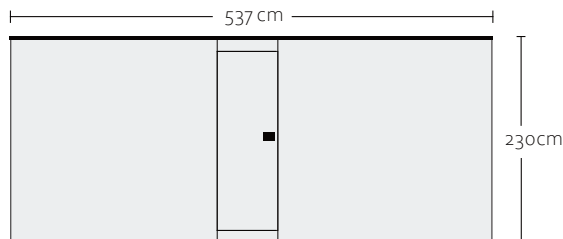
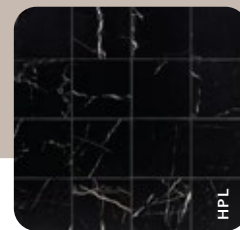



				
<b>fully prefabricated</b>	<b>tough ALU door</b>	<b>massive interior</b>	<b>single glazing</b>	<b>practical canopy</b>

**Standard configuration:**

<b>DIMENSIONS</b>	227x 233x 230 cm
<b>WEIGHT</b>	1050 kg
<b>WINDOWS / GLAZING</b>	Front side single glazing 8mm / transparent glass
<b>DOOR</b>	Aluminium frame, non-locking, single glazed
<b>FLOORING</b>	HPL
<b>INTERIOR WALLS</b>	Rustic tyrol wood cladding, heat treated and brushed
<b>BENCHES</b>	Thermo aspen
<b>BACKREST</b>	Thermo aspen
<b>CONTROL UNIT</b>	Harvia Fenix wifi control panel
<b>COLOR LIGHT THERAPY</b>	LED RGB under the bench and behind the backrest incl. remote control
<b>HEATER</b>	Harvia Qubic gkW black steel
<b>FACADES</b>	Glass, tyrol lamellas natural, sheet metal on the back side
<b>RAINWATER DRAINAGE</b>	Along the rear-side drip plate

**Available options:**

<b>GLAZING</b>	Mirror, parsol grey, parsol dark grey
<b>DOOR</b>	Door lock, antipanic - EN179
<b>FACADES</b>	Tyrol lamellas black painted
<b>HEATERS</b>	Fin and Bio heaters from Harvia, EOS, or any other manufacturer by request
<b>ILLUMINATION</b>	Digital addressable LED interior illumination, outdoor ambient illumination below sauna, vertical LED stripes integrated in facade
<b>IR HEATERS</b>	Up to 3 pcs full spectrum heaters

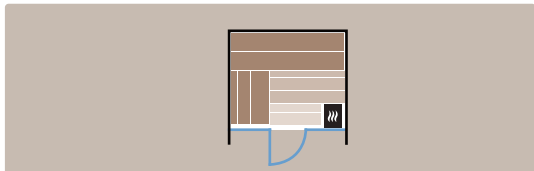

## Conditions to be provided by the customer:

**POWER CABLE:** 400 V / 5 x 2.5 mm<sup>2</sup> wire gauge, 3 x 16 Amp C-type fuse, 2 meter length, equipped with 400 volt 16A-6p-6h IP44 female connector. Your sauna will be supplied with the corresponding compatible connector, facilitating a hassle-free and secure electrical connection.

**FOUNDATION:** Flat and solid; a reinforced concrete slab, matching the dimensions of the sauna, with a thickness of 15 cm, the sauna is set on adjustable feet for leveling and alignment.

**INSTALLATION:** Accessibility to the installation site for crane delivery must be checked and ensured. **IMPORTANT:** It is the customer's responsibility to arrange for the crane or other delivery means and to clarify all requirements for installation in advance.

**DELIVERY & ASSEMBLY:** The sauna is prefabricated in the factory and is delivered directly to the construction site by prior arrangement. Generally, the customer is responsible for organizing all installation measures unless otherwise agreed. Final assembly, including electrical connection for testing, commissioning, functional testing, training, and handover will be carried out by the seller's or manufacturer's assembly team.



# C cute XL



**fully  
prefabricated**



**tough  
ALU door**



**massive  
interior**



**single  
glazing**



**practical  
canopy**

## Standard configuration:

<b>DIMENSIONS</b>	322 x 233 x 230 cm
<b>WEIGHT</b>	1450 kg
<b>WINDOWS / GLAZING</b>	Front side single glazing 8mm / transparent glass
<b>DOOR</b>	Aluminium frame, non-locking, single glazed
<b>FLOORING</b>	HPL
<b>INTERIOR WALLS</b>	Rustic tyrol wood cladding, heat treated and brushed
<b>BENCHES</b>	Thermo aspen
<b>BACKREST</b>	Thermo aspen
<b>CONTROL UNIT</b>	Harvia Fenix wifi control panel
<b>COLOR LIGHT THERAPY</b>	LED RGB under the bench and behind the backrest incl. remote control
<b>HEATER</b>	Harvia Qubic gkW black steel
<b>FACADES</b>	Glass, tyrol lamellas natural, sheet metal on the back side
<b>RAINWATER DRAINAGE</b>	Along the rear-side drip plate

## Available options:

<b>GLAZING</b>	Mirror, parsol grey, parsol dark grey
<b>DOOR</b>	Door lock, antipanic - EN179
<b>FACADES</b>	Tyrol lamellas black painted
<b>HEATERS</b>	Fin and Bio heaters from Harvia, EOS, or any other manufacturer by request
<b>ILLUMINATION</b>	Digital addressable LED interior illumination, outdoor ambient illumination below sauna, vertical LED stripes integrated in facade
<b>IR HEATERS</b>	Up to 3 pcs full spectrum heaters



## Conditions to be provided by the customer:

**POWER CABLE:** 400V / 5 x 2.5 mm<sup>2</sup> wire gauge, 3 x 16 Amp C-type fuse, 2 meter length, equipped with 400 volt 16A-6p-6h IP44 female connector. Your sauna will be supplied with the corresponding compatible connector, facilitating a hassle-free and secure electrical connection.

**FOUNDATION:** Flat and solid; a reinforced concrete slab, matching the dimensions of the sauna, with a thickness of 15 cm, the sauna is set on adjustable feet for leveling and alignment.

**INSTALLATION:** Accessibility to the installation site for crane delivery must be checked and ensured. **IMPORTANT:** It is the customer's responsibility to arrange for the crane or other delivery means and to clarify all requirements for installation in advance.

**DELIVERY & ASSEMBLY:** The sauna is prefabricated in the factory and is delivered directly to the construction site by prior arrangement. Generally, the customer is responsible for organizing all installation measures unless otherwise agreed. Final assembly, including electrical connection for testing, commissioning, functional testing, training, and handover will be carried out by the seller's or manufacturer's assembly team.



PARSOL DARK GREY



MIRROR

facades

benches, backrest

interior wood

floor

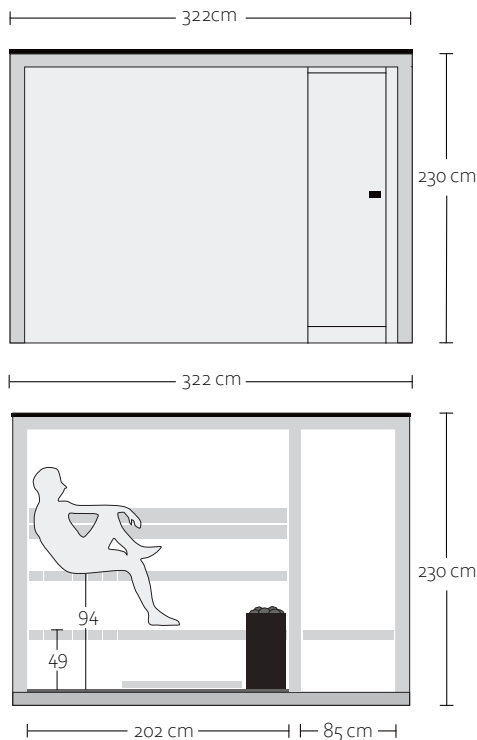
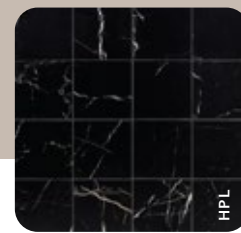
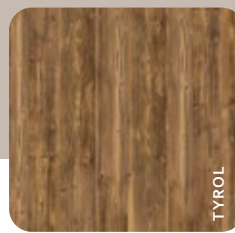



C  
cute 44



fully  
prefabricated

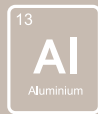

tough  
ALU door



massive  
interior



single  
glazing



practical  
canopy

### Standard configuration:

DIMENSIONS	440 x 233 x 230 cm
WEIGHT	2200 kg
WINDOWS / GLAZING	Front side single glazing 8mm / transparent glass
DOOR	Aluminium frame, non-locking, single glazed, transparent glass
FLOORING	HPL
INTERIOR WALLS	Rustic tyrol wood cladding, heat treated and brushed
BENCHES	Thermo aspen
BACKREST	Thermo aspen
CONTROL UNIT	Harvia Fenix wifi control panel
COLOR LIGHT THERAPY	LED RGB under the bench and behind the backrest incl. remote control
HEATER	Harvia Qubic 9kW black steel
LOUNGE HEATING	Ceiling IR 700W
FACADES	Glass, tyrol lamellas natural, sheet metal on the back side
RAINWATER DRAINAGE	Along the rear-side drip plate

### Available options:

GLAZING	Mirror, parsol grey, parsol dark grey
DOOR	Door lock, antipanic - EN179
FACADES	Tyrol lamellas black painted
HEATERS	Fin and Bio heaters from Harvia, EOS, or any other manufacturer by request, Floor heating 400W (4 m <sup>2</sup> )
ILLUMINATION	Digital addressable LED interior illumination, outdoor ambient illumination below sauna, vertical LED stripes integrated in facade
IR HEATERS	Up to 3 pcs full spectrum heaters

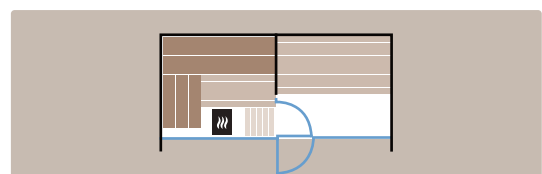

## Conditions to be provided by the customer:

**POWER CABLE:** 400V / 5 x 2.5 mm<sup>2</sup> wire gauge, 3 x 16 Amp C-type fuse, 2 meter length, equipped with 400 volt 16A-6p-6h IP44 female connector.

Your sauna will be supplied with the corresponding compatible connector, facilitating a hassle-free and secure electrical connection.

**FOUNDATION:** Flat and solid; a reinforced concrete slab, matching the dimensions of the sauna, with a thickness of 15 cm, the sauna is set on adjustable feet for leveling and alignment.

**INSTALLATION:** Accessibility to the installation site for crane delivery must be checked and ensured. **IMPORTANT:** It is the customer's responsibility to arrange for the crane or other delivery means and to clarify all requirements for installation in advance.

**DELIVERY & ASSEMBLY:** The sauna is prefabricated in the factory and is delivered directly to the construction site by prior arrangement. Generally, the customer is responsible for organizing all installation measures unless otherwise agreed. Final assembly, including electrical connection for testing, commissioning, functional testing, training, and handover will be carried out by the seller's or manufacturer's assembly team.



# C

## cute 54



**fully  
prefabricated**



**tough  
ALU door**



**massive  
interior**



**single  
glazing**



**practical  
canopy**

### Standard configuration:

DIMENSIONS	537x 233x 230 cm
WEIGHT	2400 kg
GLAZING	Front side single glazing 8mm / transparent glass
DOOR	Aluminium frame, non-locking, single glazed, transparent glass
FLOORING	HPL
INTERIOR WALLS	Rustic Tyrol wood cladding, heat treated and brushed
BENCHES	Thermo aspen
BACKREST	Thermo aspen
CONTROL UNIT	Harvia Fenix wifi control panel
COLOR LIGHT THERAPY	LED RGB under the bench and behind the backrest incl. remote control
SHOWER	Integrated
HEATER	Harvia Qubic 9kW black steel
LOUNGE HEATING	Ceiling IR 700W, floor heating 500W (5 m <sup>2</sup> )
FACADES	Glass, tyrol lamellas natural, sheet metal on the back side
RAINWATER DRAINAGE	Along the rear-side drip plate

### Available options:

GLAZING	Mirror, parsol grey, parsol dark grey
DOOR	Door lock, antipanic - EN179
FACADES	Tyrol lamellas black painted
HEATERS	Fin and Bio heaters from Harvia, EOS, or any other manufacturer by request
ILLUMINATION	Digital addressable LED interior illumination, outdoor ambient illumination below sauna, vertical LED stripes integrated in facade
IR HEATERS	Up to 3 pcs full spectrum heaters

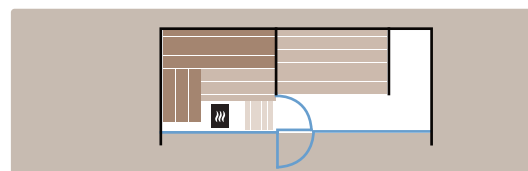

## Conditions to be provided by the customer:

**POWER CABLE:** 400 V / 5 x 2,5 mm<sup>2</sup> wire gauge, 3 x 16 Amp C-type fuse, 2 meter length , equipped with 400 volt 16A-6p-6h IP44 female connector.

Your sauna will be supplied with the corresponding compatible connector, facilitating a hassle-free and secure electrical connection.

**WATER SUPPLY:** Cold and hot water supply (¾" pipe), drain or wastewater connection prepared at site

**FOUNDATION:** Flat and solid; a reinforced concrete slab, matching the dimensions of the sauna, with a thickness of 15 cm, the sauna is set on adjustable feet for leveling and alignment.

**INSTALLATION:** Accessibility to the installation site for crane delivery must be checked and ensured. **IMPORTANT:** It is the customer's responsibility to arrange for the crane or other delivery means and to clarify all requirements for installation in advance.

**DELIVERY & ASSEMBLY:** The sauna is prefabricated in the factory and is delivered directly to the construction site by prior arrangement. Generally, the customer is responsible for organizing all installation measures unless otherwise agreed. Final assembly, including electrical connection for testing, commissioning, functional testing, training, and handover will be carried out by the seller's or manufacturer's assembly team.



# b balcony



**fully  
prefabricated**

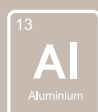

**tough  
ALU door**



**massive  
interior**



**double  
glazing**



**design for reduce  
static load**

## Standard configuration:

DIMENSIONS	217 x 160 x 225 cm
WEIGHT	900 kg
WINDOWS / GLAZING	2 sides double glazed / mirror
DOOR	Aluminium frame, double glazed. Door lock, antipanic - EN179
FLOORING	HPL
INTERIOR WALLS	Rustic Tyrol wood cladding, heat treated and brushed
BENCHES	Thermo aspen
BACKREST	Thermo aspen
CONTROL UNIT	Harvia Fenix wifi control panel
COLOR LIGHT THERAPY	LED RGB under the bench and behind the backrest incl. remote control
HEATER	Harvia The The Wall g kW
FACADES	Glass, sheet metal on the back side
RAINWATER DRAINAGE	Rear wall-integrated concealed gutter with rear water outlet

## Available options:

FACADES	FMAX moonwalk, patina bronze, stonehenge skyline, IPE veertical, IPE Wave
GLAZING	Parsol grey, parsol dark grey, transparent, mirror+
HEATERS	Fin and Bio heaters from Harvia, EOS, or any other manufacturer by request
ILLUMINATION	Digital addressable LED interior illumina- tion, outdoor ambient illumination below sauna
IR HEATERS	Up to 3 pcs full spectrum heaters
WINDOW	Starry sky window



## Conditions to be provided by the customer:

**POWER CABLE:** 400 V / 5 x 2.5 mm<sup>2</sup> wire gauge, 3 x 16 Amp C-type fuse, 2 meter length, equipped with 400 volt 16A-6p-6h IP44 female connector. Your sauna will be supplied with the corresponding compatible connector, facilitating a hassle-free and secure electrical connection.

**FOUNDATION:** Flat and solid; a reinforced concrete slab, matching the dimensions of the sauna, with a thickness of 15 cm, the sauna is set on adjustable feet for leveling and alignment.

**INSTALLATION:** Accessibility to the installation site for crane delivery must be checked and ensured. **IMPORTANT:** It is the customer's responsibility to arrange for the crane or other delivery means and to clarify all requirements for installation in advance.

**DELIVERY & ASSEMBLY:** The sauna is prefabricated in the factory and is delivered directly to the construction site by prior arrangement. Generally, the customer is responsible for organizing all installation measures unless otherwise agreed. Final assembly, including electrical connection for testing, commissioning, functional testing, training, and handover will be carried out by the seller's or manufacturer's assembly team.



# p panorama



**fully  
prefabricated**

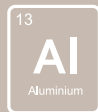

**tough  
ALU door**



**massive  
interior**



**double  
glazing**



**180 degrees of  
openness**

## Standard configuration:

DIMENSIONS	220 x 200 x 225 cm
WEIGHT	1000 kg
WINDOWS / GLAZING	3 sides, double glazed / mirror
DOOR	Aluminium frame, double glazed Door lock, antipanic - EN179
FLOORING	HPL
INTERIOR WALLS	Rustic Tyrol wood cladding, heat treated and brushed
BENCHES	Thermo aspen
BACKREST	Thermo aspen
CONTROL UNIT	Harvia Fenix Wifi control panel
COLOR LIGHT THERAPY	LED RGB under the bench and behind the backrest incl. remote control
HEATER	Harvia Qubic 9 kW black steel
FACADES	Glass, Sheet metal on the back side
RAINWATER DRAINAGE	Side wall-integrated concealed gutter with side water outlet

## Available options:

GLAZING	Parsol grey, parsol dark grey, transparent, mirror+
HEATERS	Fin and Bio heaters from Harvia, EOS, or any other manufacturer by request
ILLUMINATION	Digital addressable LED interior illumination, outdoor ambient illumination below sauna
IR HEATERS	Up to 3 pcs full spectrum heaters
WINDOW	Starry sky window

## BENCHES LAYOUTS

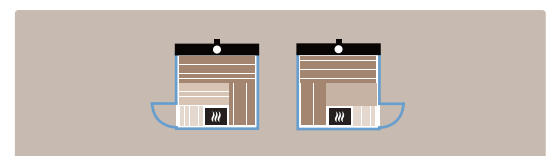

## Conditions to be provided by the customer:

**POWER CABLE:** 400 V / 5 x 2.5 mm<sup>2</sup> wire gauge, 3 x 16 Amp C-type fuse, 2 meter length , equipped with 400 volt 16A-6p-6h IP44 female connector. Your sauna will be supplied with the corresponding compatible connector, facilitating a hassle-free and secure electrical connection.

**FOUNDATION:** Flat and solid; a reinforced concrete slab, matching the dimensions of the sauna, with a thickness of 15 cm, the sauna is set on adjustable feet for leveling and alignment.

**INSTALLATION:** Accessibility to the installation site for crane delivery must be checked and ensured. **IMPORTANT:** It is the customer's responsibility to arrange for the crane or other delivery means and to clarify all requirements for installation in advance.

**DELIVERY & ASSEMBLY:** The sauna is prefabricated in the factory and is delivered directly to the construction site by prior arrangement. Generally, the customer is responsible for organizing all installation measures unless otherwise agreed. Final assembly, including electrical connection for testing, commissioning, functional testing, training, and handover will be carried out by the seller's or manufacturer's assembly team.



TRANSPARENT



PARSOL DARK GREY



PARSOL GREY

benches, backrest

interior wood

floor

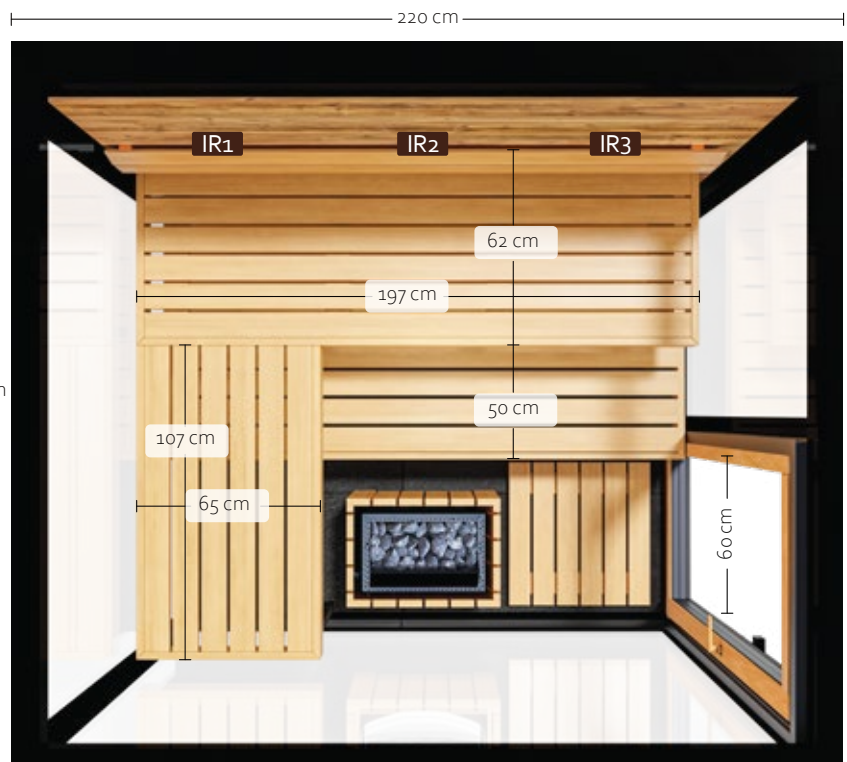
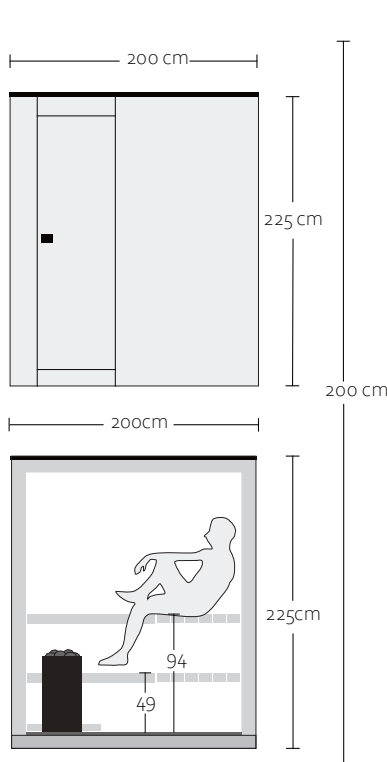
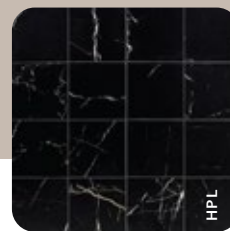
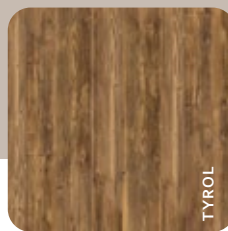

# 1 loma



**fully  
prefabricated**



**tough  
ALU door**



**massive  
interior**



**double  
glazing**



**award-winning  
design**

## Standard configuration:

DIMENSIONS	220 x 220 x 233 cm
WEIGHT	1300 kg
WINDOWS / GLAZING	3 sides, double glazed / mirror
DOOR	Aluminium frame, double glazed Door lock, antipanic - EN179
FLOORING	Tiles
INTERIOR WALLS	Rustic tyrol wood cladding, heat treated and brushed
BENCHES	Thermo aspen
BACKREST	Thermo aspen
CONTROL UNIT	Harvia Fenix wifi control panel
HEATER	Harvia Cilindro gkW black Steel
FACADES	Glass, sheet metal on the back side
RAINWATER DRAINAGE	Side wall-integrated concealed gutter with side water outlet

## Available options:

GLAZING	Parsol grey, parsol dark grey, mirror+ transparent
HEATERS	Fin and Bio heaters from Harvia, EOS, or any other manufacturer by request digital addressable LED interior
ILLUMINATION	illumination, outdoor ambient illumination below sauna
IR HEATERS	Up to 2 pcs full spectrum heaters
WINDOWS	Starry sky window

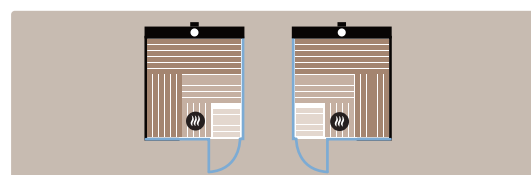

## Conditions to be provided by the customer:

**POWER CABLE:** 400 V / 5 x 2.5 mm<sup>2</sup> wire gauge, 3 x 16 Amp C-type fuse, 2 meter length , equipped with 400 volt 16A-6p-6h IP44 female connector. Your sauna will be supplied with the corresponding compatible connector, facilitating a hassle-free and secure electrical connection.

**FOUNDATION:** Flat and solid; a reinforced concrete slab, matching the dimensions of the sauna, with a thickness of 15 cm, the sauna is set on adjustable feet for leveling and alignment.

**INSTALLATION:** Accessibility to the installation site for crane delivery must be checked and ensured. **IMPORTANT:** It is the customer's responsibility to arrange for the crane or other delivery means and to clarify all requirements for installation in advance.

**DELIVERY & ASSEMBLY:** The sauna is prefabricated in the factory and is delivered directly to the construction site by prior arrangement. Generally, the customer is responsible for organizing all installation measures unless otherwise agreed. Final assembly, including electrical connection for testing, commissioning, functional testing, training, and handover will be carried out by the seller's or manufacturer's assembly team.



TRANSPARENT



PARSOL GREY



PARSOL DARK GREY

benches, backrest

interior wood

floor

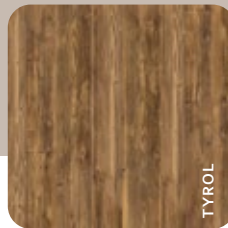

a  
amade



reddot winner 2021  
best of the best



fully  
prefabricated

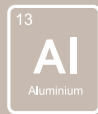

tough  
ALU door



massive  
interior



double  
glazing



award-winning  
design

### Standard configuration:

DIMENSIONS	220 x 220 x 233 cm
WEIGHT	1250 kg
WINDOWS / GLAZING	3 sides, double glazed / mirror
DOOR	Aluminium frame, double glazed Door lock, antipanic - EN179
FLOORING	Tiles
INTERIOR WALLS	Rustic Tyrol wood cladding, heat treated and brushed
BENCHES	Thermo aspen
BACKREST	Thermo aspen
CONTROL UNIT	Harvia Fenix wifi control panel
HEATER	Harvia Qubic 9 kW black steel
FACADES	Glas, sheet metal on the back side
RAINWATER DRAINAGE	Rear wall-integrated concealed gutter with side water outlet

### Available options:

GLAZING	Parsol grey, parsol dark grey, mirror+, transparent
HEATERS	Fin and Bio heaters from Harvia, EOS, or any other manufacturer by request
ILLUMINATION	Digital addressable LED interior illumination, outdoor ambient illumination below sauna
IR HEATERS	Up to 2 pcs full spectrum heaters
WINDOW	Starry sky window

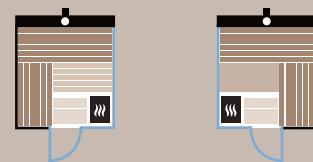

## Conditions to be provided by the customer:

**POWER CABLE:** 400 V / 5 x 2.5 mm<sup>2</sup> wire gauge, 3 x 16 Amp C-type fuse, 2 meter length , equipped with 400 volt 16A-6p-6h IP44 female connector. Your sauna will be supplied with the corresponding compatible connector, facilitating a hassle-free and secure electrical connection.

**FOUNDATION:** Flat and solid; a reinforced concrete slab, matching the dimensions of the sauna, with a thickness of 15 cm, the sauna is set on adjustable feet for leveling and alignment.

**INSTALLATION:** Accessibility to the installation site for crane delivery must be checked and ensured. **IMPORTANT:** It is the customer's responsibility to arrange for the crane or other delivery means and to clarify all requirements for installation in advance.

**DELIVERY & ASSEMBLY:** The sauna is prefabricated in the factory and is delivered directly to the construction site by prior arrangement. Generally, the customer is responsible for organizing all installation measures unless otherwise agreed. Final assembly, including electrical connection for testing, commissioning, functional testing, training, and handover will be carried out by the seller's or manufacturer's assembly team.



# a

## amade xl



**fully  
prefabricated**

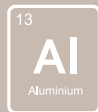

**tough  
ALU door**



**massive  
interior**



**double  
glazing**



**practical  
anteroom**

### Standard configuration:

DIMENSIONS	300 x 220 x 233 cm
WEIGHT	1700 kg
WINDOWS / GLAZING	3 sides double glazed / mirror
DOOR	Aluminium frame, double glazed Door lock, antipanic - EN179
FLOORING	Tiles
INTERIOR WALLS	Rustic Tyrol wood cladding, heat treated and brushed
BENCHES	Thermo aspen
BACKREST	Thermo aspen
CONTROL UNIT	Harvia Fenix wifi control panel
COLOR LIGHT THERAPY	LED RGB under the bench and behind the backrest incl. remote control
HEATER	Harvia Legend Home 11 kW black
FACADES	Sheet metal on the back side
RAINWATER DRAINAGE	Rear wall-integrated concealed gutter with rear water outlet

### Available options:

GLAZING	Parsol grey, parsol dark grey, mirror+, transparent
HEATERS	Fin and Bio heaters from Harvia, EOS, or any other manufacturer by request
ILLUMINATION	Digital addressable LED interior illumination, outdoor ambient illumination below sauna
IR HEATERS	Up to 2 pcs full spectrum heaters
WINDOW	Starry sky window

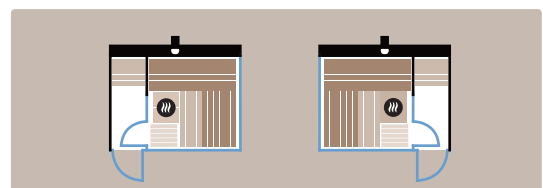

## Conditions to be provided by the customer:

**POWER CABLE:** 400 V / 5 x 2.5 mm<sup>2</sup> wire gauge, 3 x 16 Amp C-type fuse, 2 meter length, equipped with 400 volt 16A-6p-6h IP44 female connector. Your sauna will be supplied with the corresponding compatible connector, facilitating a hassle-free and secure electrical connection.

**FOUNDATION:** Flat and solid; a reinforced concrete slab, matching the dimensions of the sauna, with a thickness of 15 cm, the sauna is set on adjustable feet for leveling and alignment.

**INSTALLATION:** Accessibility to the installation site for crane delivery must be checked and ensured. **IMPORTANT:** It is the customer's responsibility to arrange for the crane or other delivery means and to clarify all requirements for installation in advance.

**DELIVERY & ASSEMBLY:** The sauna is prefabricated in the factory and is delivered directly to the construction site by prior arrangement. Generally, the customer is responsible for organizing all installation measures unless otherwise agreed. Final assembly, including electrical connection for testing, commissioning, functional testing, training, and handover will be carried out by the seller's or manufacturer's assembly team.



TRANSPARENT



PARSOL GREY



PARSOL DARK GREY

benches, backrest

interior wood

floor

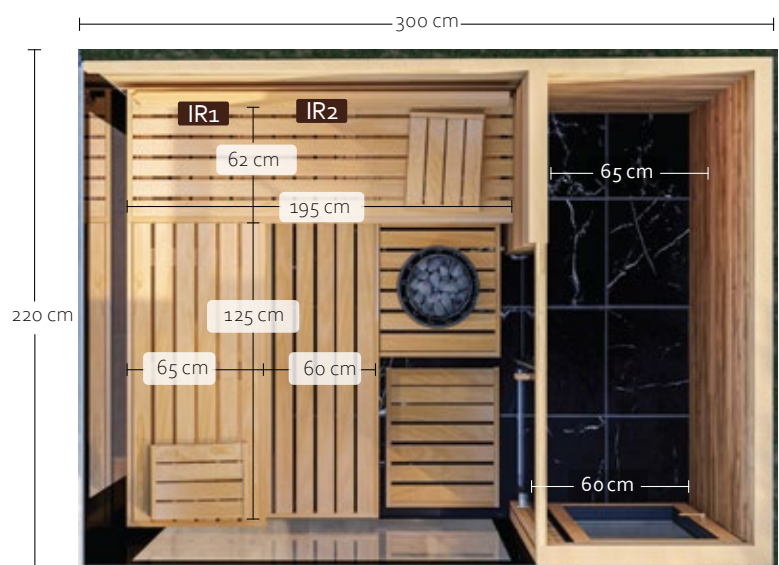
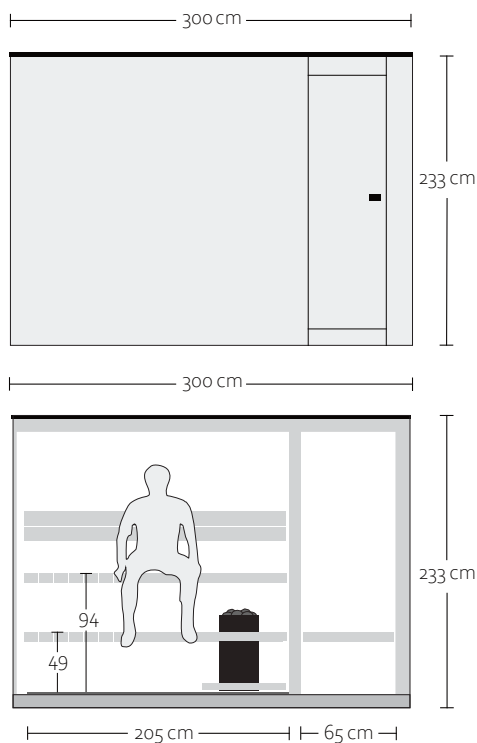
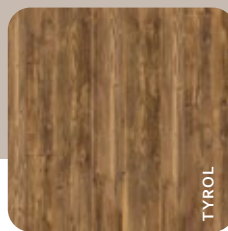



fully  
prefabricated

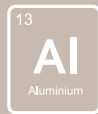

tough  
ALU door



massive  
interior



double  
glazing



enduring  
elegance

### Standard configuration:

DIMENSIONS	240 x 230 x 233 cm
WEIGHT	1600 kg
WINDOWS / GLAZING	2 sides, double glazing / transparent
DOOR	Aluminium frame, glazed, transparent glass Door lock, antipanic - EN179
FLOORING	Tiles
INTERIOR WALLS	Rustic Tyrol wood cladding, heat treated and brushed
BENCHES	Thermo aspen
BACKREST	Thermo aspen
CONTROL UNIT	Digital touch control panel Harvia Xenio
COLOR LIGHT THERAPY	LED RGB under the bench and behind the backrest incl. remote control
HEATER	Harvia Cilindro black steel 11kW
FACADES	Glass, sheet metal on the back side
RAINWATER DRAINAGE	Side wall-integrated concealed gutter with side water outlet

### Available options:

GLAZING	Parsol grey, parsol dark grey, mirror/mirror+
HEATERS	Fin and Bio heaters from Harvia, EOS, or any other manufacturer by request
FACADES	FMAX (cave, moonwalk, patina bronze, stonehenge, skyline)
ILLUMINATION	Digital addressable LED interior illumination, outdoor ambient illumination below sauna, Vertical LED stripes integrated in facade
IR HEATERS	Up to 3 pcs full spectrum heaters
WINDOW	Starry sky window

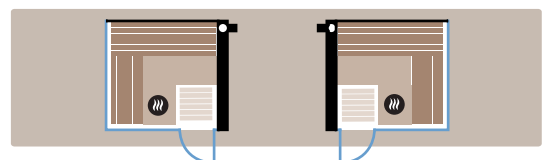

## Conditions to be provided by the customer:

**POWER CABLE:** 400 V / 5 x 2.5 mm<sup>2</sup> wire gauge, 3 x 16 Amp C-type fuse, 2 meter length, equipped with 400 volt 16A-6p-6h IP44 female connector. Your sauna will be supplied with the corresponding compatible connector, facilitating a hassle-free and secure electrical connection.

**FOUNDATION:** Flat and solid; a reinforced concrete slab, matching the dimensions of the sauna, with a thickness of 15 cm, the sauna is set on adjustable feet for leveling and alignment.

**INSTALLATION:** Accessibility to the installation site for crane delivery must be checked and ensured. **IMPORTANT:** It is the customer's responsibility to arrange for the crane or other delivery means and to clarify all requirements for installation in advance.

**DELIVERY & ASSEMBLY:** The sauna is prefabricated in the factory and is delivered directly to the construction site by prior arrangement. Generally, the customer is responsible for organizing all installation measures unless otherwise agreed. Final assembly, including electrical connection for testing, commissioning, functional testing, training, and handover will be carried out by the seller's or manufacturer's assembly team.



PARSOL GREY



PARSOL DARK GREY



MIRROR / MIRROR+

benches, backrest

interior wood

floor

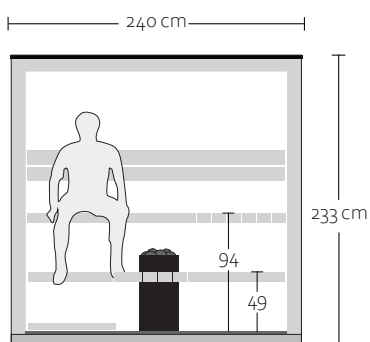
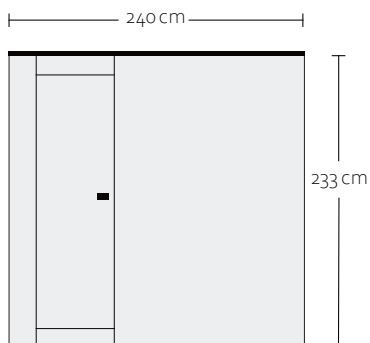
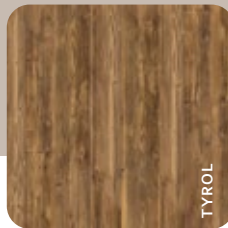

230 cm

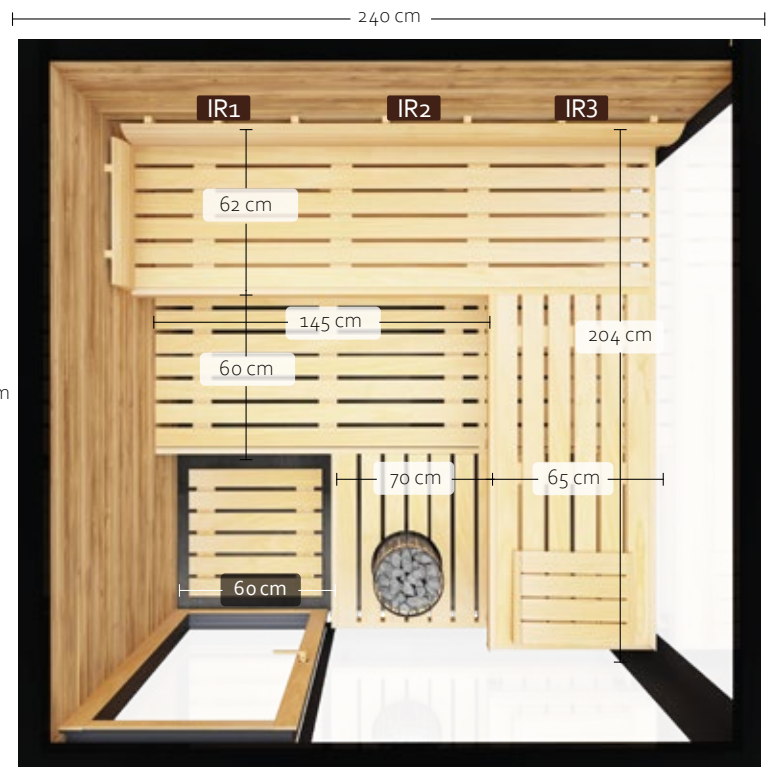



**fully  
prefabricated**



**tough  
ALU door**



**massive  
interior**



**double  
glazing**



**180 degrees of  
openness**

### Standard configuration:

DIMENSIONS	225 x 300 x 242 cm
WEIGHT	1500 kg
WINDOWS / GLAZING	3 sides, double glazed / mirror
DOOR	Aluminium frame, double glazed / mirror Door lock, antipanic - EN179
FLOORING	HPL
INTERIOR WALLS	Rustic Tyrol wood cladding, heat treated and brushed
BENCHES	Thermo aspen
BACKREST	Thermo aspen
CONTROL UNIT	Harvia Fenix wifi control panel
COLOR LIGHT THERAPY	LED RGB under the bench and behind the backrest incl. remote control
HEATER	EOS Cubo Avantgarde 12kW
FACADES	Glass, Sheet metal on the back side
RAINWATER DRAINAGE	Side wall-integrated concealed gutter with side water outlet

### Available options:

GLAZING	Parsol dark grey, transparent, mirror+
HEATERS	Fin and Bio heaters from Harvia, EOS, or any other manufacturer by request
ILLUMINATION	Digital addressable LED interior illumination, outdoor ambient illumination below sauna, Vertical LED stripes integrated in facade
IR HEATERS	Up to 3 pcs full spectrum heaters Starry sky window
BENCH ADDON	Footrest

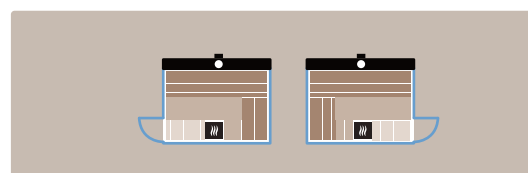

## Conditions to be provided by the customer:

**POWER CABLE:** 400 V / 5 x 2.5 mm<sup>2</sup> wire gauge, 3 x 16 Amp C-type fuse, 2 meter length , equipped with 400 volt 16A-6p-6h IP44 female connector. Your sauna will be supplied with the corresponding compatible connector, facilitating a hassle-free and secure electrical connection.

**FOUNDATION:** Flat and solid; a reinforced concrete slab, matching the dimensions of the sauna, with a thickness of 15 cm, the sauna is set on adjustable feet for leveling and alignment.

**INSTALLATION:** Accessibility to the installation site for crane delivery must be checked and ensured. **IMPORTANT:** It is the customer's responsibility to arrange for the crane or other delivery means and to clarify all requirements for installation in advance.

**DELIVERY & ASSEMBLY:** The sauna is prefabricated in the factory and is delivered directly to the construction site by prior arrangement. Generally, the customer is responsible for organizing all installation measures unless otherwise agreed. Final assembly, including electrical connection for testing, commissioning, functional testing, training, and handover will be carried out by the seller's or manufacturer's assembly team.



TRANSPARENT



PARSOL DARK GREY

benches, backrest

interior wood

floor

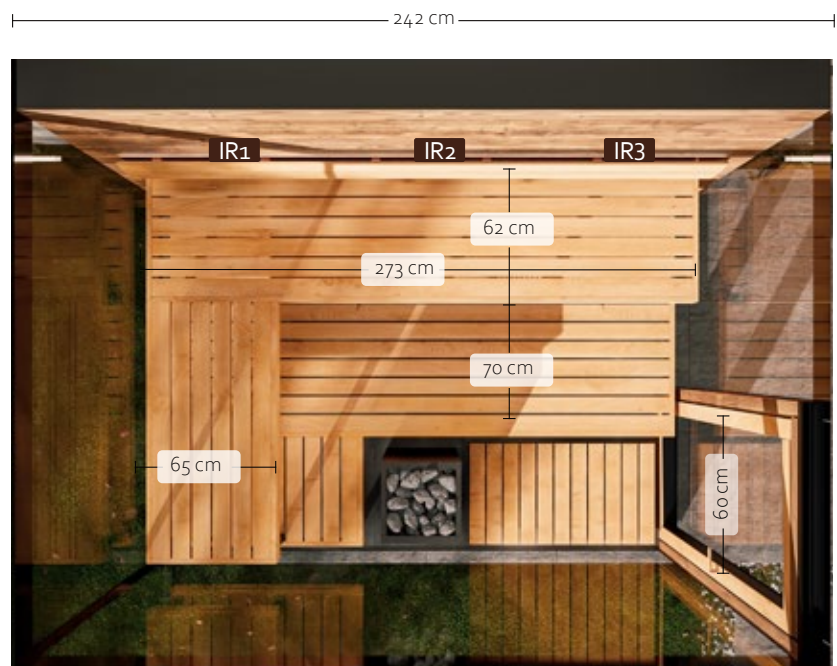
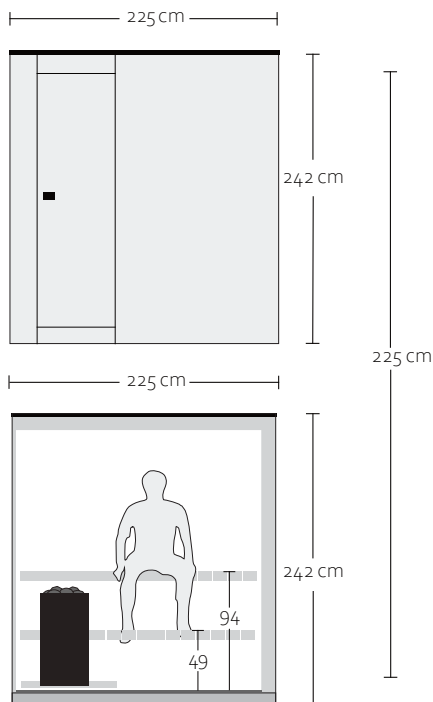
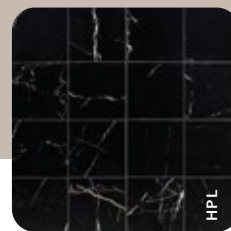
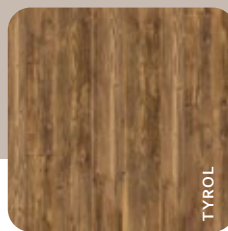



reddot winner 2023



fully prefabricated

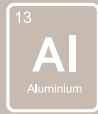

tough ALU door



massive interior



double glazing



a vibrant selection of decorative elements

### Standard configuration:

DIMENSIONS	230 x 230 x 233 cm
WEIGHT	1500 kg
WINDOWS / GLAZING	2 sides, double glazed / parsol dark grey
DOOR	Aluminium frame, double glazed Door lock, antipanic - EN179
FLOORING	Tiles
INTERIOR WALLS	Rustic tyrol wood cladding, heat treated and brushed
BENCHES	Thermo aspen
BACKREST	Thermo aspen
CONTROL UNIT	Harvia Fenix wifi control panel
COLOR LIGHT THERAPY	LED RGB under the bench and behind the backrest incl. remote control
HEATER	Harvia Virta 11kW
FACADES	IPE Wave, sheet metal on the back side
RAINWATER DRAINAGE	Rear wall-integrated concealed gutter with rear water outlet

### Available options:

FACADES	IPE vertical, larch, IPE wave, FMAX (cave, moonwalk, patina bronze, stonehenge, skyline), tyrol natural, tyrol black
GLAZING	mirror bronze, mirror/mirror+, transparent
HEATERS	Fin and Bio heaters from Harvia, EOS, or any other manufacturer by request
ILLUMINATION	Digital addressable LED interior illumination, outdoor ambient illumination below sauna
IR HEATERS	Up to 4 pcs full spectrum heaters
WINDOW	Starry sky window

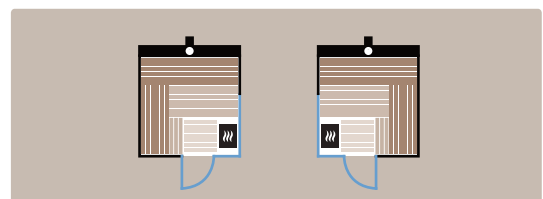

## Conditions to be provided by the customer:

**POWER CABLE:** 400 V / 5 x 2.5 mm<sup>2</sup> wire gauge, 3 x 16 Amp C-type fuse, 2 meter length, equipped with 400 volt 16A-6p-6h IP44 female connector. Your sauna will be supplied with the corresponding compatible connector, facilitating a hassle-free and secure electrical connection.

**FOUNDATION:** Flat and solid; a reinforced concrete slab, matching the dimensions of the sauna, with a thickness of 15 cm, the sauna is set on adjustable feet for leveling and alignment.

**INSTALLATION:** Accessibility to the installation site for crane delivery must be checked and ensured. **IMPORTANT:** It is the customer's responsibility to arrange for the crane or other delivery means and to clarify all requirements for installation in advance.

**DELIVERY & ASSEMBLY:** The sauna is prefabricated in the factory and is delivered directly to the construction site by prior arrangement. Generally, the customer is responsible for organizing all installation measures unless otherwise agreed. Final assembly, including electrical connection for testing, commissioning, functional testing, training, and handover will be carried out by the seller's or manufacturer's assembly team.

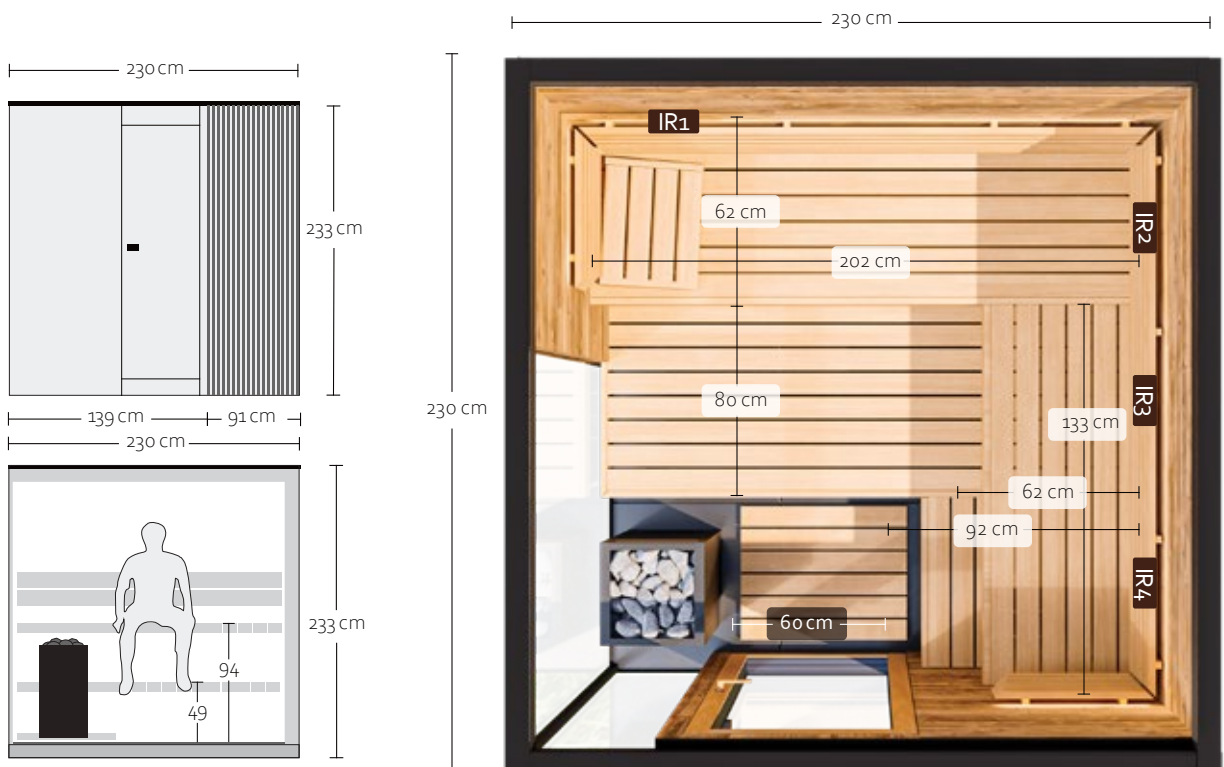



velden xl



reddot winner 2023



fully prefabricated

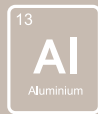

tough ALU door



massive interior



double glazing



practical anteroom

### Standard configuration:

DIMENSIONS	330 x 230 x 233 cm
WEIGHT	2100 kg
WINDOWS / GLAZING	3 sides double glazed / mirror bronze
DOOR	Aluminium frame, double glazed Door lock, antipanic - EN179
FLOORING	Tiles
INTERIOR WALLS	Rustic Tyrol wood cladding, heat treated and brushed
BENCHES	Thermo aspen
BACKREST	Thermo aspen
CONTROL UNIT	Harvia Fenix wifi control panel
COLOR LIGHT THERAPY	LED RGB under the bench and behind the backrest incl. remote control
HEATER	Harvia Virta 11 kW
FACADES	Glass, IPE wave, sheet metal on the back side
RAINWATER DRAINAGE	Rear wall-integrated concealed gutter with rear water outlet

### Available options:

FACADES	Larch, IPE vertical IPE wave, FMAX (cave, moonwalk, patina bronze, stonehenge, skyline), tyrol natural, tyrol Black
GLAZING	Parsol dark grey, mirror/mirror+, transparent
HEATERS	Fin and Bio heaters from Harvia, EOS, or any other manufacturer by request
ILLUMINATION	Digital addressable LED interior illumination, outdoor ambient illumination below sauna
IR HEATERS	Up to 2 pcs full spectrum heaters
WINDOW	Starry sky window

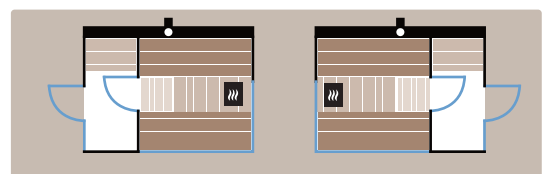

## Conditions to be provided by the customer:

**POWER CABLE:** 400V / 5 x 2.5 mm<sup>2</sup> wire gauge, 3 x 16 Amp C-type fuse, 2 meter length, equipped with 400 volt 16A-6p-6h IP44 female connector. Your sauna will be supplied with the corresponding compatible connector, facilitating a hassle-free and secure electrical connection.

**FOUNDATION:** Flat and solid; a reinforced concrete slab, matching the dimensions of the sauna, with a thickness of 15 cm, the sauna is set on adjustable feet for leveling and alignment.

**INSTALLATION:** Accessibility to the installation site for crane delivery must be checked and ensured. **IMPORTANT:** It is the customer's responsibility to arrange for the crane or other delivery means and to clarify all requirements for installation in advance.

**DELIVERY & ASSEMBLY:** The sauna is prefabricated in the factory and is delivered directly to the construction site by prior arrangement. Generally, the customer is responsible for organizing all installation measures unless otherwise agreed. Final assembly, including electrical connection for testing, commissioning, functional testing, training, and handover will be carried out by the seller's or manufacturer's assembly team.



f  
flora



fully prefabricated



tough ALU door



massive interior



double glazing



automated watering living wall

### Standard configuration:

DIMENSIONS	242 x 240 x 235 cm
WEIGHT	1800 kg
WINDOWS / GLAZING	Side window, double glazed / mirror
DOOR	Aluminium frame, double glazed Door lock, antipanic - EN179
FLOORING	Tiles
INTERIOR WALLS	Rustic Tyrol wood cladding, heat treated and brushed
BENCHES	Thermo aspen
BACKREST	Thermo aspen
CONTROL UNIT	Harvia Fenix wifi control panel
COLOR LIGHT THERAPY	LED RGB under the bench and behind the backrest incl. remote control
HEATER	Harvia Virta 11 kW
FACADES	Glass, garden wall, sheet metal on the back side
RAINWATER DRAINAGE	Rear wall-integrated concealed gutter with rear water outlet

### Available options:

GLAZING	Parsol dark grey, mirror/mirror+
HEATERS	Fin and Bio heaters from Harvia, EOS, or any other manufacturer by request
ILLUMINATION	Digital addressable LED interior illumination, outdoor ambient illumination below sauna
IR HEATERS	Up to 3 pcs full spectrum heaters
WINDOW	Starry sky window

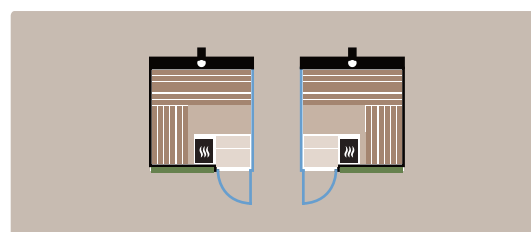

## Conditions to be provided by the customer:

**POWER CABLE:** 400 V / 5 x 2.5 mm<sup>2</sup> wire gauge, 3 x 16 Amp C-type fuse, 2 meter length, equipped with 400 volt 16A-6p-6h IP44 female connector. Your sauna will be supplied with the corresponding compatible connector, facilitating a hassle-free and secure electrical connection.

**FOUNDATION:** Flat and solid; a reinforced concrete slab, matching the dimensions of the sauna, with a thickness of 15 cm, the sauna is set on adjustable feet for leveling and alignment.

**INSTALLATION:** Accessibility to the installation site for crane delivery must be checked and ensured. **IMPORTANT:** It is the customer's responsibility to arrange for the crane or other delivery means and to clarify all requirements for installation in advance.

**DELIVERY & ASSEMBLY:** The sauna is prefabricated in the factory and is delivered directly to the construction site by prior arrangement. Generally, the customer is responsible for organizing all installation measures unless otherwise agreed. Final assembly, including electrical connection for testing, commissioning, functional testing, training, and handover will be carried out by the seller's or manufacturer's assembly team.

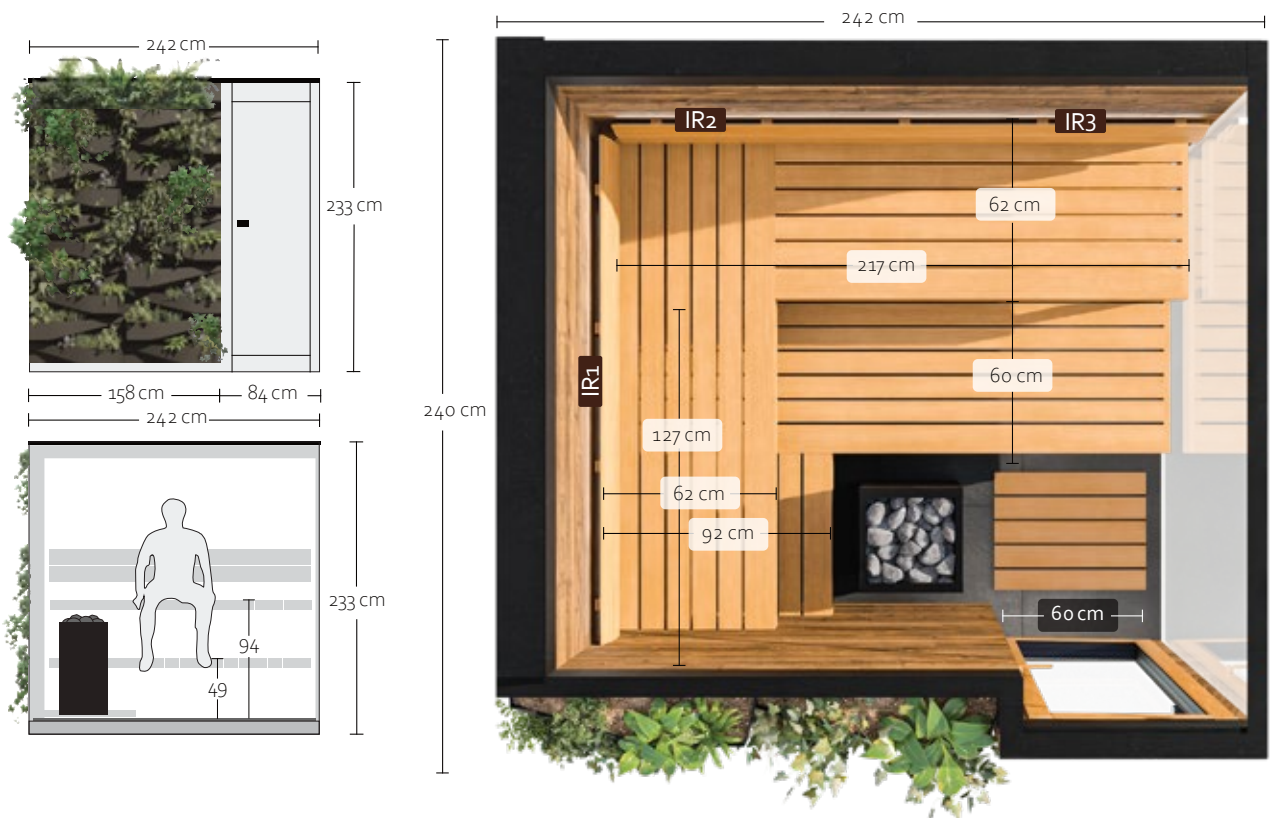



**BIG SEE  
Wood Design  
Award 2023  
Winner**



**fully  
prefabricated**

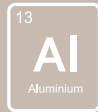

**tough  
ALU door**



**massive  
interior**



**double  
glazing**



**warmth  
of wood**

### Standard configuration:

DIMENSIONS	305 x 230 x 243 cm
WEIGHT	2000 kg
WINDOWS / GLAZING	2 sides glass, double glazing / parsol dark grey
DOOR	Aluminium frame, double glazed Door lock, antipanic - EN179
FLOORING	Tiles
INTERIOR WALLS	Rustic Tyrol wood cladding, heat treated and brushed
BENCHES	Thermo aspen, ergonomic lounger
BACKREST	Thermo aspen
COLOR LIGHT THERAPY	LED RGB under the bench and behind the backrest incl. remote control
HEATER	Harvia Pro 20 kW - wood burning heater
FACADES	Glass, IPE vertical, Sheet metal on the back side
RAINWATER DRAINAGE	Rear wall-integrated concealed gutter with rear water outlet

### Available options:

FACADES	Larch, IPE wave, FMAX (cave, moonwalk, patina bronze, stonehenge, skyline), tyrol natural, tyrol Black
GLAZING	Parsol bronze, grey, mirror/mirror+, Transparent
CONTROL UNIT	Harvia Fenix wifi control panel
HEATERS	Additional electric heater (6 or 9 kw) - hybrid heating
ILLUMINATION	Digital addressable LED interior illumination, outdoor ambient illumination below sauna
IR HEATERS	Up to 2 pcs full spectrum heaters

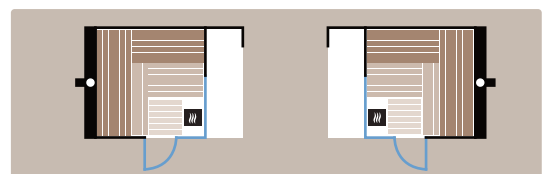

## Conditions to be provided by the customer:

**POWER CABLE:** 400 V / 2 x 2.5 mm<sup>2</sup> wire gauge, 3 x 16 Amp C-type fuse, 2 meter length, equipped with 400 volt 16A-6p-6h IP44 female connector. Your sauna will be supplied with the corresponding compatible connector, facilitating a hassle-free and secure electrical connection.

**FOUNDATION:** Flat and solid; a reinforced concrete slab, matching the dimensions of the sauna, with a thickness of 15 cm, the sauna is set on adjustable feet for leveling and alignment.

**INSTALLATION:** Accessibility to the installation site for crane delivery must be checked and ensured. **IMPORTANT:** It is the customer's responsibility to arrange for the crane or other delivery means and to clarify all requirements for installation in advance.

**DELIVERY & ASSEMBLY:** The sauna is prefabricated in the factory and is delivered directly to the construction site by prior arrangement. Generally, the customer is responsible for organizing all installation measures unless otherwise agreed. Final assembly, including electrical connection for testing, commissioning, functional testing, training, and handover will be carried out by the seller's or manufacturer's assembly team.

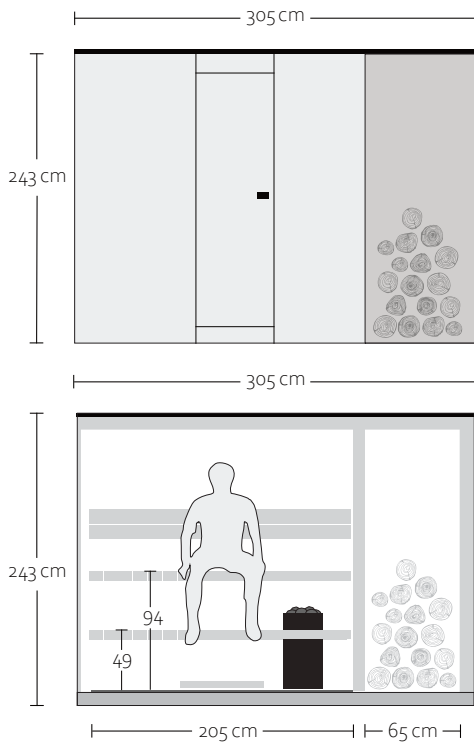



<b>fully prefabricated</b>	<b>tough ALU door</b>	<b>massive interior</b>	<b>double glazing</b>	<b>oversized skylight</b>

**Standard configuration:**

DIMENSIONS	280 x 230 x 270 cm
WEIGHT	2100 kg
WINDOWS / GLAZING	4 sides glass, double glazing / Parsol dark grey
DOOR	Aluminium frame, double glazed Door lock, antipanic - EN179
FLOORING	Tiles
INTERIOR WALLS	Rustic Tyrol wood cladding, heat treated and brushed
BENCHES	Thermo aspen, ergonomic lounger
BACKREST	Thermo aspen
CONTROL UNIT	Harvia Fenix wifi control panel
COLOR LIGHT THERAPY	LED RGB under the bench and behind the backrest incl. remote control
HEATER	Harvia Virta 11kW
FACADES	Glass, IPE vertical, sheet metal on the back side
RAINWATER DRAINAGE	Along the rear-side drip plate

**Available options:**

FACADES	Larch, IPE vertical, FMAX (cave, moonwalk, patina bronze, stonehenge, skyline)
GLAZING	Parsol bronze, grey, mirror/mirror+, transparent
HEATERS	Fin and Bio heaters from Harvia, EOS, or any other manufacturer by request
ILLUMINATION	Digital addressable LED interior illumination, outdoor ambient illumination below sauna
IR HEATERS	Up to 3 pcs full spectrum heaters

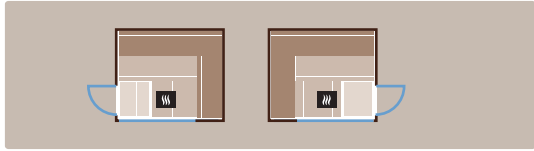

## Conditions to be provided by the customer:

**POWER CABLE:** 400 V / 5 x 2.5 mm<sup>2</sup> wire gauge, 3 x 16 Amp C-type fuse, 2 meter length, equipped with 400 volt 16A-6p-6h IP44 female connector. Your sauna will be supplied with the corresponding compatible connector, facilitating a hassle-free and secure electrical connection.

**FOUNDATION:** Flat and solid; a reinforced concrete slab, matching the dimensions of the sauna, with a thickness of 15 cm, the sauna is set on adjustable feet for leveling and alignment.

**INSTALLATION:** Accessibility to the installation site for crane delivery must be checked and ensured. **IMPORTANT:** It is the customer's responsibility to arrange for the crane or other delivery means and to clarify all requirements for installation in advance.

**DELIVERY & ASSEMBLY:** The sauna is prefabricated in the factory and is delivered directly to the construction site by prior arrangement. Generally, the customer is responsible for organizing all installation measures unless otherwise agreed. Final assembly, including electrical connection for testing, commissioning, functional testing, training, and handover will be carried out by the seller's or manufacturer's assembly team.





wellness  
oasis



fully  
prefabricated

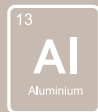

tough  
ALU door



massive  
interior



double  
glazing



oversized  
skylight

### Standard configuration:

DIMENSIONS	407 x 245 x 286 cm
WEIGHT	3500 kg
WINDOWS / GLAZING	4 sides glass, double glazing / parsol dark grey
DOOR	Aluminium frame, double glazed Door lock, antipanic - EN179
FLOORING	Tiles
INTERIOR WALLS	Rustic tyrol wood cladding, heat treated and brushed
BENCHES	Thermo aspen, ergonomic lounger
BACKREST	Thermo aspen
CONTROL UNIT	Harvia Fenix wifi control panel
COLOR LIGHT THERAPY	LED RGB under the bench and behind the backrest incl. remote control
HEATER	Harvia hidden Heater 12 kW
FACADES	Glass, IPE vertical
RAINWATER DRAINAGE	Along the rear-side drip plate
WINDOW	Starry sky window

### Available options:

FACADES	Larch, IPE wave, FMAX (cave, moonwalk, patina bronze, stonehenge, skyline)
GLAZING	Parsol bronze, grey, mirror/mirror+, transparent
HEATERS	Fin and Bio heaters from Harvia, EOS, or any other manufacturer by request
ILLUMINATION	Digital addressable LED interior illumination, outdoor ambient illumination below sauna
ENTERTAINMENT	Laser projector, sound system
IR HEATERS	Up to 3 pcs full spectrum heaters
ADDITIONS	Chill Tub, outdoor kitchen



## Conditions to be provided by the customer:

**POWER CABLE:** 400 V / 5 x 2.5 mm<sup>2</sup> wire gauge, 3 x 16 Amp C-type fuse, 2 meter length, equipped with 400 volt 16A-6p-6h IP44 female connector. Your sauna will be supplied with the corresponding compatible connector, facilitating a hassle-free and secure electrical connection.

**FOUNDATION:** Flat and solid; a reinforced concrete slab, matching the dimensions of the sauna, with a thickness of 15 cm, the sauna is set on adjustable feet for leveling and alignment.

**INSTALLATION:** Accessibility to the installation site for crane delivery must be checked and ensured. **IMPORTANT:** It is the customer's responsibility to arrange for the crane or other delivery means and to clarify all requirements for installation in advance.

**DELIVERY & ASSEMBLY:** The sauna is prefabricated in the factory and is delivered directly to the construction site by prior arrangement. Generally, the customer is responsible for organizing all installation measures unless otherwise agreed. Final assembly, including electrical connection for testing, commissioning, functional testing, training, and handover will be carried out by the seller's or manufacturer's assembly team.

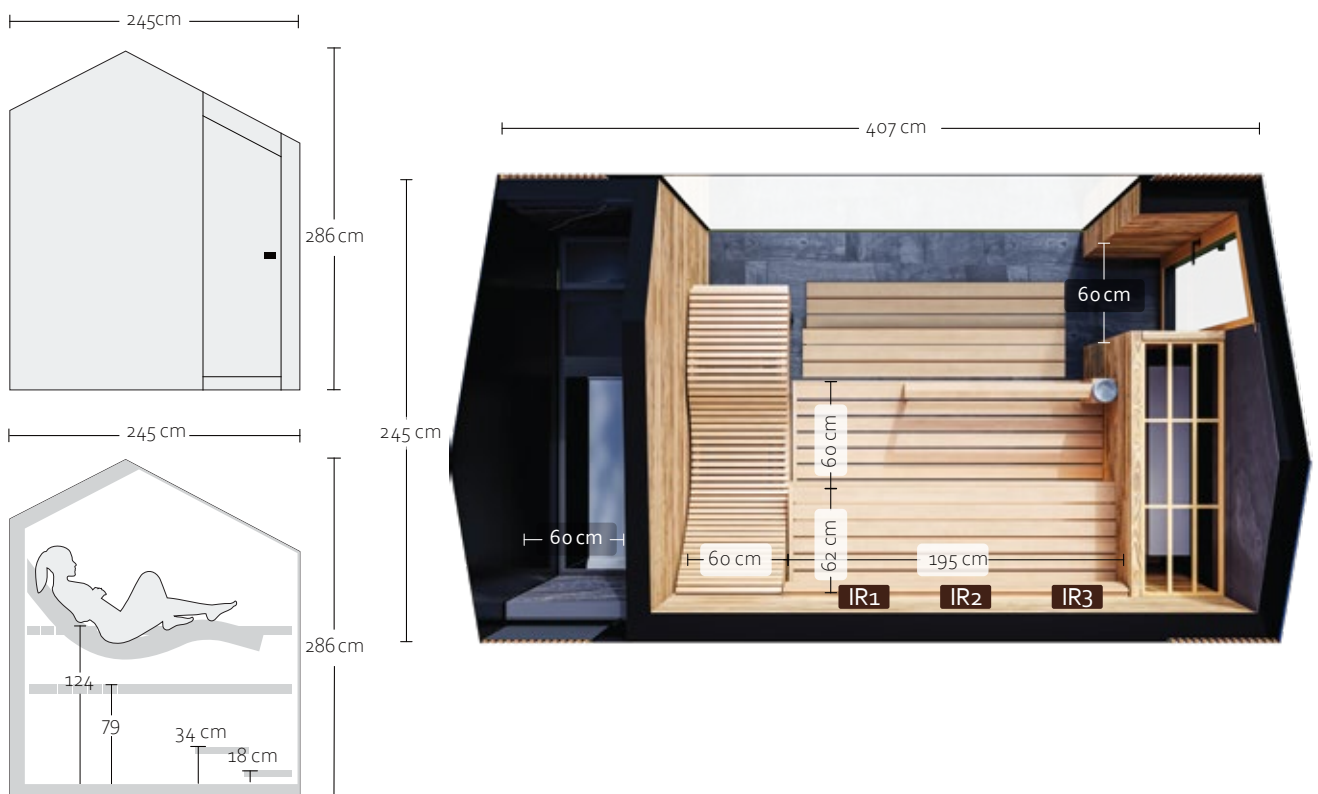

# S

sauna house



**fully  
prefabricated**

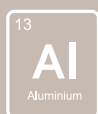

**tough  
ALU door**



**massive  
interior**



**double  
glazing**



**whole  
house**

## Standard configuration:

DIMENSIONS	550 x 240 x 243 cm
WEIGHT	4000 kg
WINDOWS / GLAZING	3 sides glass, double glazed / parsol dark grey
DOOR	Sliding doors, aluminium frame, double glazed Door lock, antipanic - EN179
FLOORING	Tiles
INTERIOR WALLS	Rustic tyrol wood cladding, heat treated and brushed
BENCHES	Thermo aspen, ergonomic lounge
BACKREST	Thermo aspen
CONTROL UNIT	Harvia Fenix Wifi control panel
COLOR LIGHT THERAPY	LED RGB under the bench and behind the backrest incl. remote control
HEATER	Harvia Cilindro Black Steel 11 kW
FACADES	Glass, Sheet metal on the back side
RAINWATER DRAINAGE	Rear wall-integrated concealed gutter with rear water outlet

## Available options:

DOORS	Additional sliding doors
FACADES	Larch, IPE wave, FMAX (cave, moonwalk, patina bronze, stonehenge, skyline), tyrol lamellas natural, tyrol lamellas black
GLAZING	Parsol bronze, grey, mirror/mirror+
HEATERS	Fin and Bio heaters from Harvia, EOS, or any other manufacturer by request
LOUNGE HEATING	Floor heating 600 W (6m <sup>2</sup> )
ILLUMINATION	Digital addressable LED interior illumination, outdoor ambient illumination below sauna
IR HEATERS	Up to 4 pcs full spectrum heaters Ceiling 700 W heater
WINDOW	Starry sky window

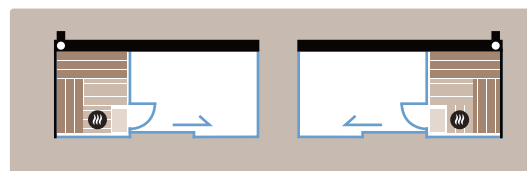

## Conditions to be provided by the customer:

**POWER CABLE:** 400V / 5 x 2.5 mm<sup>2</sup> wire gauge, 3 x 16 Amp C-type fuse, 2 meter length, equipped with 400 volt 16A-6p-6h IP44 female connector.

For secure electrical connection certified electrician is advised - by the seller's or manufacturer's electrician team.

**FOUNDATION:** Flat and solid; a reinforced concrete slab, matching the dimensions of the sauna, with a thickness of 15 cm, the sauna is set on adjustable feet for leveling and alignment.

**INSTALLATION:** Accessibility to the installation site for crane delivery must be checked and ensured. **IMPORTANT:** It is the customer's responsibility to arrange for the crane or other delivery means and to clarify all requirements for installation in advance.

**DELIVERY & ASSEMBLY:** The sauna is prefabricated in the factory and is delivered directly to the construction site by prior arrangement. Generally, the customer is responsible for organizing all installation measures unless otherwise agreed. Final assembly, including electrical connection for testing, commissioning, functional testing, training, and handover will be carried out by the seller's or manufacturer's assembly team.



TRANSPARENT



PARSOL GREY



MIRROR / MIRROR +

facades

benches, interior  
backrest wood floor

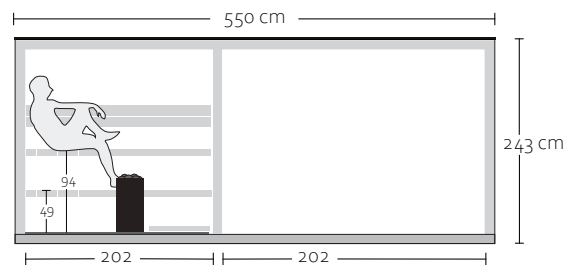
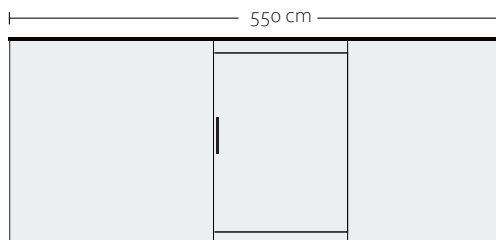

550 cm



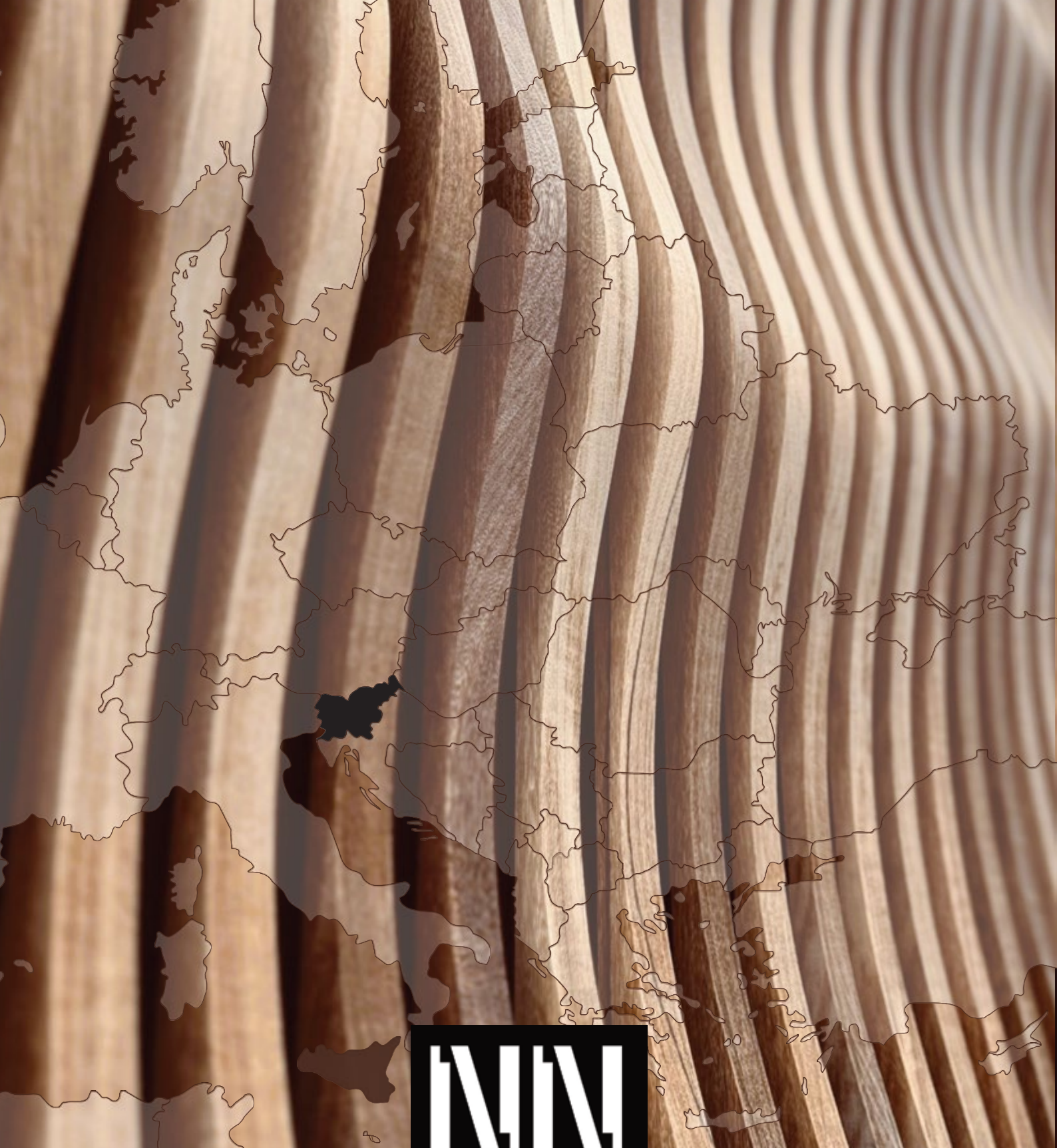

nnsaunas.com — +386 (0)2 729 01 60

Gočova 10, 2235 Sveta Trojica v Slovenskih goricah — Slovenia